

# XBee-PRO PKG-R™ RS-232 RF Modem

---

XBee-PRO RS-232 RF Modem  
Interfacing Protocol  
RF Modem Operation  
RF Modem Configuration  
Appendices

## Product Manual v1.x82

For XBee-PRO RF Modem Part Numbers: XBP24-PKI-...-R...

IEEE® 802.15.4 Stand-alone RF Modems by MaxStream, Inc.



**MaxStream®**

355 South 520 West, Suite 180

Lindon, UT 84042

Phone: (801) 765-9885

Fax: (801) 765-9895

rf-xperts@maxstream.net  
www.MaxStream.net (live chat support)

M100280  
2006.04.24

**© 2006 MaxStream, Inc. All rights reserved**

No part of the contents of this manual may be transmitted or reproduced in any form or by any means without the written permission of MaxStream, Inc.

XBee-PRO PKG-R™ is a trademark of MaxStream, Inc.

**Technical Support:**

Phone: (801) 765-9885

Live Chat: [www.maxstream.net](http://www.maxstream.net)

E-mail: [rf-xperts@maxstream.net](mailto:rf-xperts@maxstream.net)

# Contents

<b>1. XBee-PRO RS-232 RF Modem</b>	<b>4</b>	<b>Appendix A: Agency Certifications</b>	<b>48</b>
<b>1.1. Features Overview</b>	<b>4</b>	<b>FCC Certification</b>	<b>48</b>
1.1.1. Worldwide Acceptance	4	OEM Labeling Requirements	48
<b>1.2. Specifications</b>	<b>5</b>	FCC Notices	48
<b>1.3. External Interface</b>	<b>6</b>	FCC-Approved Antennas (2.4 GHz)	49
<b>2. Interfacing Protocol</b>	<b>7</b>	<b>European Certification</b>	<b>50</b>
<b>2.1. RS-232 Operation</b>	<b>7</b>	OEM Labeling Requirements	50
2.1.1. Pin Signals	7	Restrictions	50
2.1.2. Wiring Diagrams	8	Declarations of Conformity	50
<b>3. RF Modem Operation</b>	<b>9</b>	Approved Antennas	51
<b>3.1. Serial Communications</b>	<b>9</b>	<b>IC (Industry Canada) Certification</b>	<b>51</b>
3.1.1. RS-232 Data Flow	9	Labeling Requirements	51
3.1.2. Host and RF Modem Settings	9	<b>Appendix B: Additional Information</b>	<b>52</b>
3.1.3. Flow Control	10	<b>1-Year Warranty</b>	<b>52</b>
3.1.4. Transparent Operation	11	<b>Ordering Information</b>	<b>52</b>
3.1.5. API Operation	11	<b>Contact MaxStream</b>	<b>53</b>
<b>3.2. IEEE 802.15.4 Networks</b>	<b>12</b>		
3.2.1. NonBeacon	12		
3.2.2. NonBeacon (w/ Coordinator)	12		
3.2.3. Association	13		
<b>3.3. Modes of Operation</b>	<b>16</b>		
3.3.1. Idle Mode	16		
3.3.2. Transmit / Receive Modes	16		
3.3.3. Sleep Mode	18		
3.3.4. Command Mode	20		
<b>3.4. Addressing</b>	<b>21</b>		
3.4.1. Unicast Mode	21		
3.4.2. Broadcast Mode	21		
<b>4. RF Modem Configuration</b>	<b>22</b>		
<b>4.1. Programming the RF Modem</b>	<b>22</b>		
4.1.1. Programming Examples	22		
<b>4.2. Command Reference Tables</b>	<b>23</b>		
<b>4.3. Command Descriptions</b>	<b>29</b>		
<b>4.4. API Operation</b>	<b>43</b>		
4.4.1. API Frame Specifications	43		
4.4.2. API Types	44		

# 1. XBee-PRO RS-232 RF Modem

The XBee-PRO RS-232 RF Modem is an IEEE 802.15.4 compliant solution that features an RS-232 interface. Out-of-box, the modem is equipped to sustain outstanding range (2-3x the range of typical 802.15.4 solutions) and requires no additional configuration for immediate RF communications. Simply feed data into one modem, then the data is sent out the other end of the wireless link.

The modem transfers a standard asynchronous serial data stream between two or more devices. Its built-in RS-232 interface allows for rapid integration into existing data systems.



## 1.1. Features Overview

### Long Range Data Integrity

- Range
  - Indoor/Urban: **up to 300'** (100m)
  - Outdoor line-of-sight: **up to 1 mile** (1.6km)
- Transmit Power: **60 mW** (18 dBm), **100 mW** (20 dBm) EIRP
- Receiver Sensitivity: **-100 dBm**
- RF Data Rate: **250,000 bps**

### Advanced Networking & Security

- Retries and Acknowledgements
- DSSS (Direct Sequence Spread Spectrum)
- Each direct sequence channels has over 65,000 unique network addresses available
- Source/Destination Addressing
- Unicast & Broadcast Communications
- Point-to-point, point-to-multipoint and peer-to-peer topologies supported
- Coordinator/End Device networking
- 128-bit Encryption (downloadable firmware version coming soon)

### Low Power

- Power Currents
  - Receive Current: 80 mA (@9V)
  - Transmit Current: 300 mA
  - Power-down Current: < 6 mA

### Easy-to-Use

- No configuration necessary for out-of box RF communications
- Free X-CTU Software (Testing and configuration software)
- Built-in RS-232 interfacing
- Small form factor
- Network compatible with other 802.15.4 devices
- AT and API Command Modes for configuring modem parameters
- Free & Unlimited Technical Support**

### 1.1.1. Worldwide Acceptance

- FCC Approved** (USA) Refer to Appendix A [p48] for FCC Requirements. Systems that include XBee-PRO RF Modems inherit MaxStream Certifications.
- Operates within the **ISM** (Industrial, Scientific & Medical) 2.4 GHz frequency band
- Manufactured under **ISO 9001:2000** registered standards
- XBee-PRO RF Modems are optimized for use in **US, Canada, Australia, Israel and Europe** (contact MaxStream for complete list of approvals).



## 1.2. Specifications

**Table 1-01. Specifications of the XBee-PRO PKG-R RS-232 RF Modem**

Specification	XBee-PRO RS-232 RF Modem
<b>Performance</b>	
Indoor/Urban Range (w/ 2.1 dB dipole antenna)	up to 300' (100 m)
Outdoor/Urban Range (w/ 2.1 dB dipole antenna)	up to 4000' (1200 m)
Transmit Power Output	60 mW, 100 mw (20 dBm) EIRP*
Receiver Sensitivity	-100 dBm (1% packet error rate)
Interface Data Rate	1200 - 115200 bps (non-standard baud rates also supported)
RF Data Rate	250,000 bps
<b>Networking &amp; Security</b>	
Frequency	ISM 2.4 GHz
Modulation	DSSS (Direct Sequence Spread Spectrum), OQPSK (Offset Quadrature Phase Shift Keying)
Supported Network Topologies	Point-to-point, Point-to-Multipoint, Peer-to-Peer & Mesh (coming soon)
Number of Channels (software selectable)	12 Direct Sequence Channels
Addressing Layers	PAN ID, Channel & Source/Destination Addresses
<b>Antenna</b>	
Connector	RPSMA (reverse polarity SMA)
Impedance	50 ohms unbalanced
<b>Power Requirements</b>	
Power Supply	5 - 14 V
Receive Current	80 mA (@ 9 Volts)
Transmit Current	300 mA (Average current when streaming data (@9600bps) = 86 mA)
Power-down Current	<6 mA
<b>Physical Properties</b>	
Size	4.500" x 2.750" x 1.125" (11.4cm x 7.0cm x 2.9cm)
Weight	5.25 oz. (150 g)
Data Connection	Female DB-9
Operating Temperature	-40 - 85° C (Industrial)
<b>Certifications (partial list)</b>	
United States (FCC Part 15.247)	OUR-XBEEPRO
Industry Canada (IC)	4214A XBEEPRO
Europe (CE)	ETSI (Max. 10 mW transmit power output)*

\* When operating in Europe: XBee-PRO RF Modems must be configured to operate at a maximum transmit power output level of 10 dBm. Set the PL parameter to "0" (10 dBm) in order to adhere to European regulations.

## 1.3. External Interface

Figure 1-01. Front View

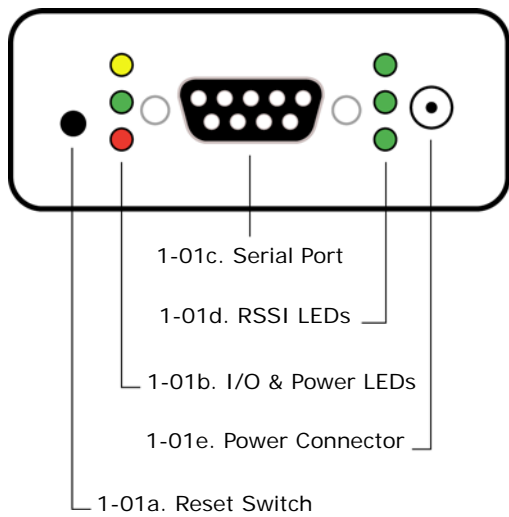

### 1-01a. Reset Switch

The Reset Switch is used to reset (re-boot) the XBee-PRO RS-232 RF Modem. This switch only applies when using the configuration tabs of MaxStream's X-CTU Software.

### 1-01b. I/O & Power LEDs

LEDs indicate RF modem activity as follows:

- Yellow (top LED) = Serial Data Out (to host)
- Green (middle) = Serial Data In (from host)
- Red (bottom) = Power/TX Indicator (LED is on when RF modem is powered)

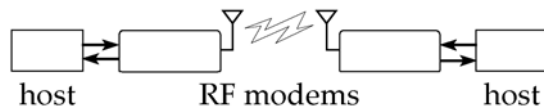

### 1-01c. Serial Port

Standard female DB-9 (RS-232) connector.

### 1-01d. RSSI LEDs

RSSI LEDs indicate the amount of fade margin present in an active wireless link. Fade margin is defined as the difference between the incoming signal strength and the modem's receiver sensitivity.

- 3 LEDs ON = Very Strong Signal (> 30 dB fade margin)
- 2 LEDs ON = Strong Signal (> 20 dB fade margin)
- 1 LED ON = Moderate Signal (> 10 dB fade margin)
- 0 LED ON = Weak Signal (< 10 dB fade margin)

### 1-01e. Power Connector

5-14 VDC power connector

Figure 1-02. Back View

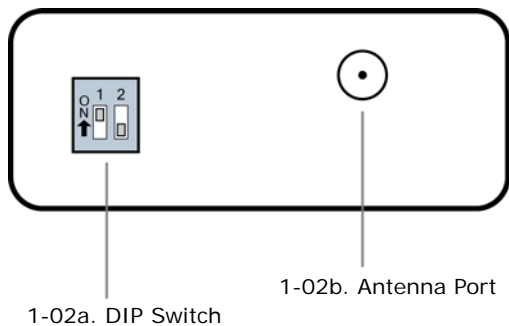

### 1-02a. DIP Switch

DIP Switch functions are not supported in this release. Future downloadable firmware versions will support DIP Switch configurations.

### 1-02b. Antenna Port

Port is a 50Ω RF signal connector for connecting to an external antenna. The connector type is RPSMA (Reverse Polarity SMA) female. The connector has threads on the outside of a barrel and a male center conductor.

## 2. Interfacing Protocol

### 2.1. RS-232 Operation

#### 2.1.1. Pin Signals

Figure 2-01. Pins used on the female RS-232 (DB-9) Serial Connector

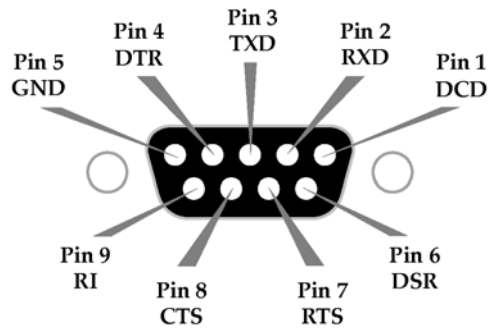

Table 2-01. Pin Assignments and Implementations

DB-9 Pin	RS-232 Name	Description	Implementation*
1	DCD	Data-Carrier-Detect	Connected to DSR (pin6)
2	RXD	Received Data	Serial data exiting the RF modem (to host)
3	TXD	Transmitted Data	Serial data entering into the RF modem (from host)
4	DTR	Data-Terminal-Ready	Can enable Power-down on the RF modem
5	GND	Ground Signal	Ground
6	DSR	Data-Set-Ready	Connected to DCD (pin1)
7	$\overline{\text{RTS}}$ / CMD	Request-to-Send / Command Mode	Provides $\overline{\text{RTS}}$ flow control or enables "Command Mode" on the RF modem
8	$\overline{\text{CTS}}$	Clear-to-Send	Provides $\overline{\text{CTS}}$ flow control
9	RI	Ring Indicator	Optional power input that is connected internally to the positive lead of the front power connector

\* Functions listed in the implementation column may not be available at the time of release.

## 2.1.2. Wiring Diagrams

### DTE RS-232 Device to a DCE RF Modem

Figure 2-02. RS-232 Device (DTE - male connector) wired to an XBee-PRO RF Modem (DCE - female)

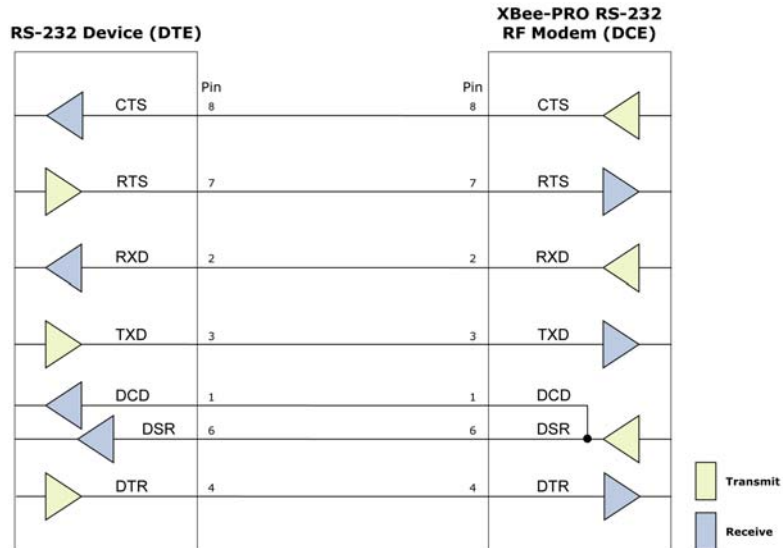

### DCE RF Modem to an DCE RS-232 Device

Figure 2-03. XBee-PRO RF Modem (DCE - female connector) wired to an RS-232 device (DCE)

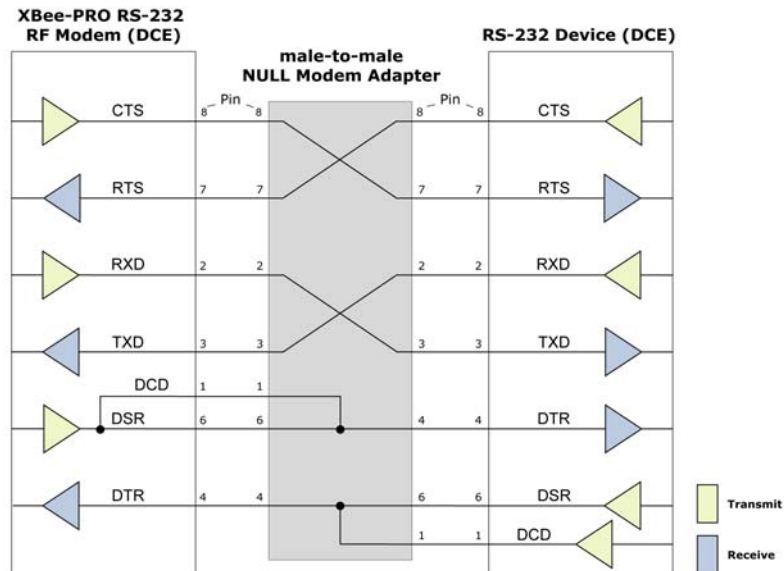

### Sample Wireless Connection: DTE <--> DCE ⚡ DCE <--> DCE

Figure 2-04. Typical wireless link between DTE and DCE devices





# 3. RF Modem Operation

## 3.1. Serial Communications

### 3.1.1. RS-232 Data Flow

The XBee-PRO RS-232 RF Modem interfaces to a host device through a standard RS-232 (DB-9) connector. Devices that have a standard RS-232 serial port can connect directly through the pins of the RF modem as shown in the figure below.

Figure 3-01. System data flow in an RS-232 environment

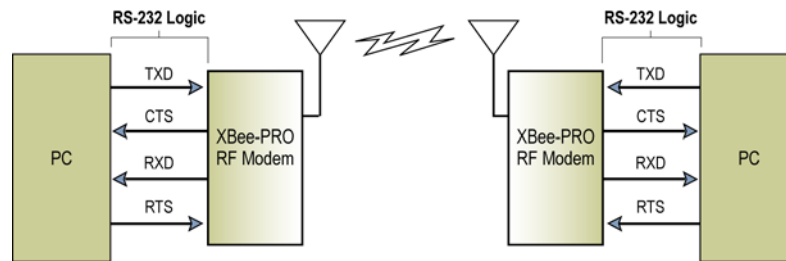

### 3.1.2. Host and RF Modem Settings

Serial communications between a host and an XBee-PRO RF Modem are dependent upon having matching baud rate, parity, stop bit & number of data bits settings. Refer to the table below to ensure host serial port settings match those of the XBee-PRO RF Modem.

Table 3-01. Parameter values critical to serial communications between the RF modem and host

Parameter Setting	Default Parameter Value
Baud (Serial Data Rate)	9600 bps (BD parameter = 3)
Number of Data Bits	8
Parity	None
Number of Stop Bits	1

Both the XBee-PRO RF Modem and host (PC) settings can be viewed and adjusted using Max-Stream's proprietary X-CTU Software. Use the "PC Settings" tab to configure host settings. Use the "Terminal" or "RF Modem Configuration" tabs to configure the RF modem settings.

NOTE: Failure to enter AT Command Mode is most commonly due to baud rate mismatch. Ensure the 'Baud' setting on the "PC Settings" tab matches the BD (Interface Data Rate) setting of the RF modem (by default, BD parameter = 3, which is associated to 9600 baud).

### 3.1.3. Flow Control

Figure 3-02. Internal Data Flow Diagram

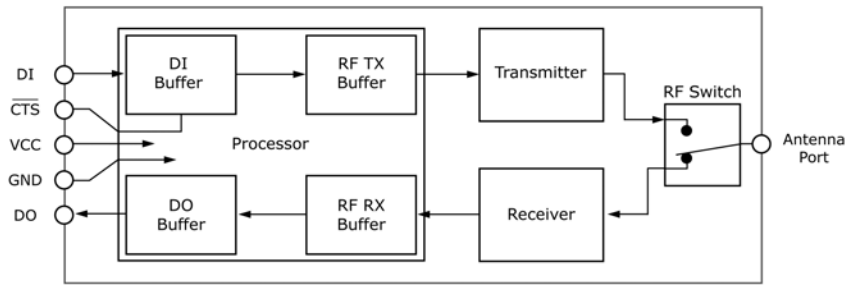

#### DI (Data In) Buffer

When serial data enters the RF modem through the DI (Data In) pin, the data is stored in the DI Buffer until it can be processed.

**Hardware Flow Control ( $\overline{\text{CTS}}$ ).** When the DI buffer is 17 bytes away from being full; by default, the modem de-asserts  $\overline{\text{CTS}}$  (high) to signal to the host device to stop sending data [refer to D7 (DIO7 Configuration) parameter].  $\overline{\text{CTS}}$  is re-asserted after the DI Buffer has 34 bytes of memory available.

#### How to eliminate the need for flow control:

1. Send messages that are smaller than the DI buffer size.
2. Interface at a lower baud rate [BD (Interface Data Rate) parameter] than the throughput data rate.

#### Case in which the DI Buffer may become full and possibly overflow:

If the modem is receiving a continuous stream of RF data, any serial data that arrives on the DI pin is placed in the DI Buffer. The data in the DI buffer will be transmitted over-the-air when the modem is no longer receiving RF data in the network.

Refer to the BD (Interface Data Rate) [p31] and RO (Packetization Timeout) [p39] command descriptions for more information.

#### DO (Data Out) Buffer

When RF data is received, the data enters the DO buffer and is sent out the serial port to a host device. Once the DO Buffer reaches capacity, any additional incoming RF data is lost.

**Hardware Flow Control ( $\overline{\text{RTS}}$ ).** If  $\overline{\text{RTS}}$  is enabled for flow control (D6 (DIO6 Configuration) Parameter = 1), data will not be sent out the DO Buffer as long as  $\overline{\text{RTS}}$  (DIO6) is de-asserted.

#### Two cases in which the DO Buffer may become full and possibly overflow:

1. If the RF data rate is set higher than the interface data rate of the modem, the modem will receive data from the transmitting modem faster than it can send the data to the host.
2. If the host does not allow the modem to transmit data out from the DO buffer because of being held off by hardware or software flow control.

### 3.1.4. Transparent Operation

---

By default, XBee-PRO RF Modems operate in Transparent Mode. When operating in this mode, the modems act as a serial line replacement - all UART data received through the DI pin is queued up for RF transmission. When RF data is received, the data is sent out the DO pin.

When the RO (Packetization Timeout) parameter threshold is satisfied [refer to RO command description], the modem attempts to initialize an RF transmission. If the modem cannot immediately transmit (for instance, if it is already receiving RF data), the serial data continues to be stored in the DI Buffer. Data is packetized and sent at any RO timeout or when 100 bytes (maximum packet size) are received.

The modem operates as described above unless the Command Mode Sequence is detected. The Command Mode Sequence consists of three copies of the command sequence character [CC parameter] surrounded by before and after guard times [GT parameter].

If the DI buffer becomes full, hardware or software flow control must be implemented in order to prevent overflow (loss of data between the host and modem).

### 3.1.5. API Operation

---

API (Application Programming Interface) Operation is an alternative to the default Transparent Operation. The frame-based API extends the level to which a host application can interact with the networking capabilities of the modem.

When in API mode, all data entering and leaving the modem is contained in frames that define operations or events within the modem.

Transmit Data Frames (received through the DI (Data In) pin) include:

- RF Transmit Data Frame
- Command Frame (equivalent to AT commands)

Receive Data Frames (sent out the Data Out) include:

- Showing a received RF packet
- A response to a command
- Showing events such as reset, associate, disassociate, etc.

The API provides alternative means of configuring modems and routing data at the host application layer. A host application can send data frames to the modem that contain address and payload information instead of using command mode to modify addresses. The modem will send data frames to the application containing status packets; as well as source, RSSI and payload information from received data packets.

The API operation option facilitates many operations such as the examples cited below:

- > Change destination addresses without having to enter command mode
- > Receive success/failure status of each RF packet
- > Identify the source address of each received packet

---

To implement API operations, refer to API sections [p43].

---

## 3.2. IEEE 802.15.4 Networks

The following IEEE 802.15.4 network types are available to the RF modem:

- NonBeacon
- NonBeacon (w/ Coordinator)

The following terms will be used to explicate the network system types:

**Table 3-02. Terms and definitions** (Applicable networking network types are designated within <brackets>.)

Term	Definition
Association	<NonBeacon (w/ Coordinator) systems only> The establishment of membership between End Devices and a Coordinator.
Coordinator	<NonBeacon (w/ Coordinator) systems only> A central RF modem that is configured to provide synchronization services through the transmission of beacons.
End Device	<i>When in the same network as a Coordinator</i> - RF modems that rely on a Coordinator for synchronization and can be put into states of sleep for low-power applications.
PAN	Personal Area Network - A data communication network that includes one or more End Devices and optionally a Coordinator.

### 3.2.1. NonBeacon

By default, XBee-PRO RF Modems are configured to support NonBeacon communications (no Coordinator). NonBeacon systems operate within a Peer-to-Peer network topology and are not dependent upon Master/Slave relationships. This means that modems remain synchronized without use of master/server configurations and each modem in the network shares both roles of master and slave. MaxStream's peer-to-peer architecture features fast synchronization times and fast cold start times. This default configuration accommodates a wide range of RF data applications.

**Figure 3-03. NonBeacon Peer-to-Peer Architecture**

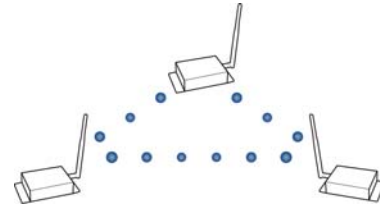

A peer-to-peer network can be established by configuring each modem to operate as an End Device (CE = 0), disabling End Device Association on all modems (A1 = 0) and setting ID and CH parameters to be identical across the network.

### 3.2.2. NonBeacon (w/ Coordinator)

A device is configured as a Coordinator by setting the CE (Coordinator Enable) parameter to "1". Coordinator power-up is governed by the A2 (Coordinator Association) command.

In a NonBeacon (w/ Coordinator) system, the Coordinator can be configured to use direct or indirect transmissions. If the SP (Cyclic Sleep Period) parameter is set to "0", the Coordinator will send data immediately. Otherwise, the SP parameter determines the length of time the Coordinator will retain the data before discarding it. Generally, SP (Cyclic Sleep Period) and ST (Time before Sleep) parameters should be set to match the SP and ST settings of the End Devices.

Association plays a critical role in the implementation of a NonBeacon (w/ Coordinator) system. Refer to the Association section [next page] for more information.

### 3.2.3. Association

Association is the establishment of membership between End Devices and a Coordinator. Association is only applicable in NonBeacon (w/ Coordinator) systems. The establishment of membership is useful in scenarios that require a central unit (Coordinator) to relay messages to or gather messages from several remote units (End Devices), assign channels or assign PAN IDs.

An RF data network that consists of one Coordinator and one or more End Devices forms a PAN (Personal Area Network). Each device in a PAN has a PAN Identifier [ID (PAN ID) parameter]. PAN IDs must be unique to prevent miscommunication between PANs. The Coordinator PAN ID is set using the ID (PAN ID) and A2 (Coordinator Association) commands.

An End Device can associate to a Coordinator without knowing the address, PAN ID or channel of the Coordinator. The A1 (End Device Association) parameter bit fields determine the flexibility of an End Device during association. The A1 parameter can be used for an End Device to dynamically set its destination address, PAN ID and/or channel.

For example: If the PAN ID of a Coordinator is known, but the operating channel is not; the A1 command on the End Device should be set to enable the 'Auto\_Associate' and 'Reassign\_Channel' bits. Additionally, the ID parameter should be set to match the PAN ID of the associated Coordinator.

#### Coordinator / End Device Setup and Operation

To configure a modem to operate as a Coordinator, set the CE (Coordinator Enable) parameter to '1'. Set the CE parameter of End Devices to '0' (default). Coordinator and End Devices should contain matching firmware versions.

#### NonBeacon (w/ Coordinator) Systems

In a NonBeacon (w/ Coordinator) system, the Coordinator can be configured to use direct or indirect transmissions. If the SP (Cyclic Sleep Period) parameter is set to '0', the Coordinator will send data immediately. Otherwise, the SP parameter determines the length of time the Coordinator will retain the data before discarding it. Generally, SP (Cyclic Sleep Period) and ST (Time before Sleep) parameters should be set to match the SP and ST settings of the End Devices.

#### Coordinator Power-up

Coordinator power-up is governed by the A2 (Coordinator Association) command. On power up, the Coordinator undergoes the following sequence of events:

##### 1. Check A2 parameter- Reassign\_PANID Flag

**Set (bit 0 = 1)** - The Coordinator issues an Active Scan. The Active Scan selects one channel and transmits a BeaconRequest command to the broadcast address (0xFFFF) and broadcast PAN ID (0xFFFF). It then listens on that channel for beacons from any Coordinator operating on that channel. The listen time on each channel is determined by the SD (Scan Duration) parameter value.

Once the time expires on that channel, the Active Scan selects another channel and again transmits the BeaconRequest as before. This process continues until all channels have been scanned, or until 5 PANs have been discovered. When the Active Scan is complete, the results include a list of PAN IDs and Channels that are being used by other PANs. This list is used to assign a unique PAN ID to the new Coordinator. The ID parameter will be retained if it is not found in the Active Scan results. Otherwise, the ID (PAN ID) parameter setting will be updated to a PAN ID that was not detected.

**Not Set (bit 0 = 0)** - The Coordinator retains its ID setting. No Active Scan is performed.

## 2. Check A2 parameter - Reassign\_Channel Flag (bit 1)

**Set (bit 1 = 1)** - The Coordinator issues an Energy Scan. The Energy Scan selects one channel and scans for energy on that channel. The duration of the scan is specified by the SD (Scan Duration) parameter. Once the scan is completed on a channel, the Energy Scan selects the next channel and begins a new scan on that channel. This process continues until all channels have been scanned.

When the Energy Scan is complete, the results include the maximal energy values detected on each channel. This list is used to determine a channel where the least energy was detected. If an Active Scan was performed (Reassign\_PANID Flag set), the channels used by the detected PANs are eliminated as possible channels. Thus, the results of the Energy Scan and the Active Scan (if performed) are used to find the best channel (channel with the least energy that is not used by any detected PAN). Once the best channel has been selected, the CH (Channel) parameter value is updated to that channel.

**Not Set (bit 1 = 0)** - The Coordinator retains its CH setting. An Energy Scan is not performed.

## 3. Start Coordinator

The Coordinator starts on the specified channel (CH parameter) and PAN ID (ID parameter). Note, these may be selected in steps 1 and/or 2 above. The Coordinator will only allow End Devices to associate to it if the A2 parameter "Allow\_Association" flag is set. Once the Coordinator has successfully started, the Associate LED will blink 1 time per second. (The LED is solid if the Coordinator has not started.)

## 4. Coordinator Changes

Once a Coordinator has started, changing A2 (Reassign\_Channel or Reassign\_PANID bits), ID, CH, or MY will cause the Coordinator to restart. Changing the A2 Allow\_Association bit will not restart the Coordinator. In a non-beaconing system, any End Devices that associated to the Coordinator prior to a Restart will not be alerted to the Coordinator restart. Thus, if the Coordinator were to change its ID, CH or MY settings, the End Devices would no longer be able to communicate with the non-beacon Coordinator. Once a Coordinator has started, the ID, CH, MY or A2 (Reassign\_Channel or Reassign\_PANID bits) should not be changed.

## End Device Power-up

End Device power-up is governed by the A1 (End Device Association) command. On power up, the End Device undergoes the following sequence of events:

### 1. Check A1 parameter - AutoAssociate Bit

**Set (bit 2 = 1)** - End Device will attempt to associate to a Coordinator. (refer to steps 2-3).

**Not Set (bit 2 = 0)** - End Device will not attempt to associate to a Coordinator. The End Device will operate as specified by its ID, CH and MY parameters. Association is considered complete and the Associate LED will blink quickly (5 times per second). When the AutoAssociate bit is not set, the remaining steps (2-3) do not apply.

### 2. Discover Coordinator (if Auto-Associate Bit Set)

The End Device issues an Active Scan. The Active Scan selects one channel and transmits a BeaconRequest command to the broadcast address (0xFFFF) and broadcast PAN ID (0xFFFF). It then listens on that channel for beacons from any Coordinator operating on that channel. The listen time on each channel is determined by the SD parameter.

Once the time expires on that channel, the Active Scan selects another channel and again transmits the BeaconRequest command as before. This process continues until all channels have been scanned, or until 5 PANs have been discovered. When the Active Scan is complete, the results include a list of PAN IDs and Channels that are being used by detected PANs.

The End Device selects a Coordinator to associate with according to the A1 parameter "Reassign\_PANID" and "Reassign\_Channel" flags:

**Reassign\_PANID Bit Set (bit 0 = 1)**- End Device can associate with a PAN with any ID value.

**Reassign\_PANID Bit Not Set (bit 0 = 0)** - End Device will only associate with a PAN whose ID setting matches the ID setting of the End Device.

**Reassign\_Channel Bit Set (bit 1 = 1)** - End Device can associate with a PAN with any CH value.

**Reassign\_Channel Bit Not Set (bit 1 = 0)**- End Device will only associate with a PAN whose CH setting matches the CH setting of the End Device.

After applying these filters to the discovered Coordinators, if multiple candidate PANs exist, the End Device will select the PAN whose transmission link quality is the strongest. If no valid Coordinator is found, the End Device will either go to sleep (as dictated by its SM (Sleep Mode) parameter) or retry Association.

Note - An End Device will also disqualify Coordinators if they are not allowing association (A2 - AllowAssociation bit); or, if the Coordinator is not using the same NonBeacon scheme as the End Device. (They must both be programmed with NonBeacon code.)

### **3. Associate to Valid Coordinator**

Once a valid Coordinator is found (step 2), the End Device sends an AssociationRequest message to the Coordinator. It then waits for an AssociationConfirmation to be sent from the Coordinator. Once the Confirmation is received, the End Device is Associated and the Associate LED will blink rapidly (2 times per second). The LED is solid if the End Device has not associated.

### **4. End Device Changes once an End Device has associated**

Changing A1, ID or CH parameters will cause the End Device to disassociate and restart the Association procedure.

If the End Device fails to associate, the AI command can give some indication of the failure.

### 3.3. Modes of Operation

XBee-PRO RF Modems operate in five modes.

**Figure 3-04. XBee-PRO RF Modem Modes of Operation**

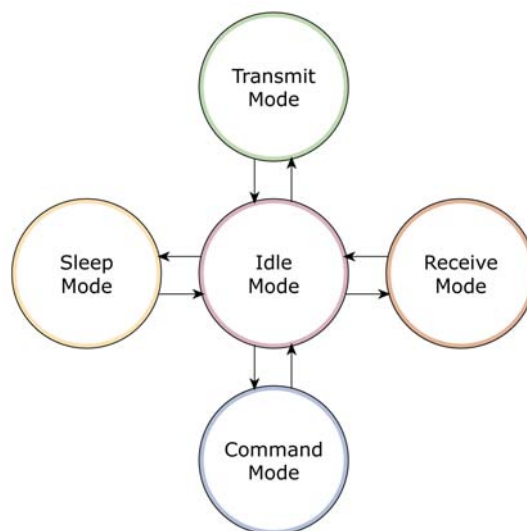

#### 3.3.1. Idle Mode

When not receiving or transmitting data, the RF modem is in Idle Mode. The modem shifts into the other modes of operation under the following conditions:

- Transmit Mode (Serial data is received in the DI Buffer)
- Receive Mode (Valid RF data is received through the antenna)
- Sleep Mode (Sleep Mode condition is met)
- Command Mode (Command Mode Sequence is issued)

#### 3.3.2. Transmit / Receive Modes

##### RF Data Packets

Each transmitted data packet contains a <Source Address> and <Destination Address> field. The <Source Address> matches the address of the transmitting modem as specified by the MY (Source Address) parameter (if MY >= 0xFFFE), the SH (Serial Number High) or the SL (Serial Number Low) parameters. The <Destination Address> field is created from the DH and DL parameter values. The <Source Address> and/or <Destination Address> fields will either contain a short 16-bit or long 64-bit address.

The RF data packet structure follows the 802.15.4 specification.

[Refer to the Addressing section [p21] for more information]

##### Direct and Indirect Transmission

There are two methods to transmit data. The first method, Direct Transmission, transmits data immediately to the <Destination Address>. The second method, Indirect Transmission, retains a packet for a period of time and transmits the data only after the destination modem (<RF Modem Source Address> = <Data Destination Address>) requests the data. Indirect Transmissions can only occur on a Coordinator. Thus, if all devices in a network are End Devices, only Direct Transmissions will occur. Indirect Transmissions are useful to ensure packet delivery to a sleeping device. The Coordinator currently is able to retain up to 2 indirect messages.



### **Direct Transmission**

A NonBeaconing Coordinator can be configured to only use Direct Transmission by setting the SP (Cyclic Sleep Period) parameter to "0". Also, a NonBeaconing Coordinator using indirect transmissions will revert to direct transmission if it knows the destination modem is awake.

To enable this behavior, the ST (Time before Sleep) value of the Coordinator must be set to match the ST value of the End Device. Once the End Device either transmits data to the Coordinator or polls the Coordinator for data, the Coordinator will use direct transmission for all subsequent data transmissions to that modem address until ST time (or number of beacons) occurs with no activity (at which point it will revert to using indirect transmissions for that modem address). "No activity" means no transmission or reception of messages with a specific address. Global messages will not reset the ST timer.

### **Indirect Transmission**

To configure Indirect Transmissions in a PAN (Personal Area Network), the SP (Cyclic Sleep Period) parameter value on the Coordinator must be set to match the longest sleep value of any End Device. The SP parameter represents time in NonBeacon systems and beacons in Beacon-enabled systems. The sleep period value on the Coordinator determines how long (time or number of beacons) the Coordinator will retain an indirect message before discarding it.

In NonBeacon networks, an End Device must poll the Coordinator once it wakes from Sleep to determine if the Coordinator has an indirect message for it. For Cyclic Sleep Modes, this is done automatically every time the modem wakes (after SP time). For Pin Sleep Modes, the A1 (End Device Association) parameter value must be set to enable Coordinator polling on pin wake-up. Alternatively, an End Device can use the FP (Force Poll) command to poll the Coordinator as needed.

### **Transmission Algorithm**

---

Prior to transmitting a packet, a CCA (Clear Channel Assessment) is performed on the channel to determine if the channel is available for transmission. The detected energy on the channel is compared with the CA (Clear Channel Assessment) parameter value. If the detected energy exceeds the CA parameter value, the packet is not transmitted.

Also, a delay is inserted before a transmission takes place. This delay is settable using the RN (Backoff Exponent) parameter. If RN is set to "0", then there is no delay before the first CCA is performed. The RN parameter value is the equivalent of the "minBE" parameter in the 802.15.4 specification. The transmit sequence follows the 802.15.4 specification.

### **Acknowledgement**

---

If the transmission is not a broadcast message, the modem will expect to receive an acknowledgement from the destination device. If an acknowledgement is not received, the packet will be resent up to 3 more times. If the acknowledgement is not received after all transmissions, an ACK failure is recorded.

### 3.3.3. Sleep Mode

Sleep Modes enable the RF modem to enter states of low-power consumption when not in use. In order to enter Sleep Mode, one of the following conditions must be met (in addition to the modem having a non-zero SM parameter value):

- DTR (Data Terminal Ready) is de-asserted.
- The modem is idle (no data transmission or reception) for the amount of time defined by the ST (Time before Sleep) parameter. [NOTE: ST is only active when SM = 4-6]

Table 3-03. Sleep Mode Configurations

Sleep Mode Setting	Transition into Sleep Mode	Transition out of Sleep Mode (wake)	Characteristics	Related Commands	Power Consumption
Pin Hibernate (SM = 1)	De-assert DTR (Data Terminal Ready)	Assert DTR	Pin/Host-controlled	(SM)	< 6 mA
Pin Doze (SM = 2)	De-assert DTR (Data Terminal Ready)	Assert DTR	Pin/Host-controlled	(SM)	< 6 mA
Cyclic Sleep (SM = 4 - 6)	Automatic transition to Sleep Mode as defined by the SM (Sleep Mode) and ST (Time before Sleep) parameters.	Transition occurs after the cyclic sleep time interval elapses. The time interval is defined by the SP (Cyclic Sleep Period) parameter.	RF modem wakes in pre-determined time intervals to detect if RF data is present.	(SM), SP, ST	< 25 mA when sleeping

The SM command is central to setting Sleep Mode configurations. By default, Sleep Modes are disabled (SM = 0) and the modem remains in Idle/Receive Mode. When in this state, the modem is constantly ready to respond to serial or RF activity.

#### Pin/Host-controlled Sleep Modes

##### Pin Hibernate (SM = 1)

- Pin/Host-controlled
- Typical power-down current: < 6 mA
- Wake-up time: 13.2 msec

Pin Hibernate Mode minimizes quiescent power (power consumed when in a state of rest or inactivity). This mode is voltage level-activated; when DTR is de-asserted, the modem will finish any transmit or receive activities, enter Idle Mode and then enter a state of sleep. The modem will not respond to either serial or RF activity while in pin sleep.

To wake a sleeping modem operating in Pin Hibernate Mode, assert DTR (Data Terminal Ready). The modem will wake when DTR is asserted and is ready to transmit or receive when the  $\overline{\text{CTS}}$  line is low. When waking the modem, the pin must be asserted at least two 'byte times' after  $\overline{\text{CTS}}$  goes low. This assures that there is time for the data to enter the DI buffer.

##### Pin Doze (SM = 2)

- Pin/Host-controlled
- Typical power-down current: < 6 mA
- Wake-up time: 2 msec

Pin Doze Mode functions as does Pin Hibernate Mode; however, Pin Doze features faster wake-up time and higher power consumption. This mode is voltage level-activated; when DTR is de-asserted, the modem will finish any transmit or receive activities, enter Idle Mode and then enter a state of sleep. The modem will not respond to either serial or RF activity while in pin sleep.

To wake a sleeping modem operating in Pin Doze Mode, assert DTR (Data Terminal Ready). The modem will wake when DTR is asserted and is ready to transmit or receive when the  $\overline{\text{CTS}}$  line is low. When waking the modem, the pin must be asserted at least two 'byte times' after  $\overline{\text{CTS}}$  goes low. This assures that there is time for the data to enter the DI buffer.

---

## Cyclic Sleep Modes

---

### Cyclic Sleep Remote (SM = 4)

- Typical Power-down Current: < 25 mA (when asleep)
- Wake-up time: 2 msec

The Cyclic Sleep Modes allow modems to periodically check for RF data. When the SM parameter is set to '4', the modem is configured to sleep, then wakes once a cycle to check for data from a modem configured as a Cyclic Sleep Coordinator (SM = 6). The Cyclic Sleep Remote sends a poll request to the Coordinator at a specific interval set by the SP (Cyclic Sleep Period) parameter. The Coordinator will transmit any queued data addressed to that specific remote upon receiving the poll request.

If no data is queued for the remote, the Coordinator will not transmit and the remote will return to sleep for another cycle. If queued data is transmitted back to the remote, it will stay awake to allow for back and forth communication until the ST (Time before Sleep) timer expires.

Also note that  $\overline{\text{CTS}}$  will go low each time the remote wakes, allowing for communication initiated by the remote host if desired.

### Cyclic Sleep Remote with Pin Wake-up (SM = 5)

Use this mode to wake a sleeping remote modem through either the RF interface or by the assertion of DTR for event-driven communications. The cyclic sleep mode works as described above (Cyclic Sleep Remote) with the addition of a pin-controlled wake-up at the remote modem. The DTR pin is edge-triggered, not level-triggered. The modem will wake when a low is detected then set  $\overline{\text{CTS}}$  low as soon as it is ready to transmit or receive.

Any activity will reset the ST (Time before Sleep) timer so the modem will go back to sleep only after there is no activity for the duration of the timer. Once the modem wakes (pin-controlled), further pin activity is ignored. The modem transitions back into sleep according to the ST time regardless of the state of the pin.

### <Cyclic Sleep Coordinator (SM = 6)>

- Typical current = Receive current
- Always awake

---

This parameter value (SM=6) exists solely for backwards compatibility with firmware version 1.x60. If backwards compatibility with the older firmware version is not required, always use the CE (Coordinator Enable) command to enable a Coordinator.

---

Use this mode to configure a modem to wake cyclic sleeping remotes through the RF interface. The cyclic sleep Coordinator will accept a message addressed to a specific remote 16 or 64-bit address and hold it in a buffer until the remote wakes and sends a poll to request the message. Messages not sent directly (buffered and requested) are called "Indirect messages". The Coordinator will only queue one indirect message at a time. The Coordinator will hold the indirect message for a period 2.5 times the sleeping period indicated by the SP (Cyclic Sleep Period) parameter. The Coordinator's SP parameter should be set to match the value used by the remotes.

The ST parameters of the Coordinator and remotes should be set to the same value because the Coordinator will track the 'awake' period of the recent 10 remotes to wake. If the Coordinator receives additional messages addressed to a remote that should be awake, the Coordinator will send a direct message to that remote instead of queuing it. The Coordinator is always awake so that any remote unit can transmit either a poll request or a data message at any time.

### 3.3.4. Command Mode

To modify or read RF Modem parameters, the modem must first enter into Command Mode - a state in which incoming characters are interpreted as commands. Two command mode types are supported: AT Command Mode and API Command Mode [p43].

#### AT Command Mode

##### To Enter AT Command Mode:

Send the 3-character command sequence “+++” and observe guard times before and after the command characters. [Refer to the “Default AT Command Mode Sequence” below.]

Default AT Command Mode Sequence (for transition to Command Mode):

- No characters sent for one second [GT (Guard Times) parameter = 0x3E8]
- Input three plus characters (“+++”) within one second [CC (Command Sequence Character) parameter = 0x2B.]
- No characters sent for one second [GT (Guard Times) parameter = 0x3E8]

All of the parameter values in the sequence can be modified to reflect user preferences.

##### To Send AT Commands:

Send AT commands and parameters using the syntax shown below.

Figure 3-05. Syntax for sending AT Commands

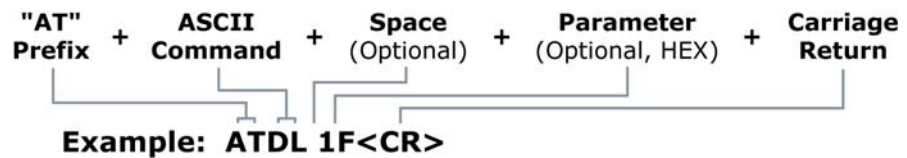

To read a parameter value stored in the RF modem’s register, leave the parameter field blank.

The preceding example would change the RF modem Destination Address (Low) to “0x1F”. To store the new value to non-volatile (long term) memory, subsequently send the WR (Write) command.

For modified parameter values to persist in the modem’s registry, changes must be saved to non-volatile memory using the WR (Write) Command. Otherwise, parameters are restored to previously saved values after the modem is powered off and then on again (or re-booted).

**System Response.** When a command is sent to the RF modem, the modem will parse and execute the command. Upon successful execution of a command, the modem returns an “OK” message. If execution of a command results in an error, the modem returns an “ERROR” message.

##### To Exit AT Command Mode:

1. Send ATCN (Exit Command Mode) Command.  
[OR]
2. If no valid AT Commands are received within the time specified by CT (Command Mode Timeout) Command, the RF modem automatically returns to Idle Mode.

For an example that illustrates programming the RF modem using AT Commands, refer to the “RF Modem Configuration” chapter [p22].

## 3.4. Addressing

Every RF data packet sent over-the-air contains a Source Address and Destination Address field in its header. The RF modem conforms to the 802.15.4 specification and supports both short 16-bit addresses and long 64-bit addresses. A unique 64-bit IEEE source address is assigned at the factory and can be read with the SL (Serial Number Low) and SH (Serial Number High) commands. Short addressing must be configured manually. A modem will use its unique 64-bit address as its Source Address if its MY (16-bit Source Address) value is "0xFFFF" or "0xFFFE".

To send a packet to a specific modem using 64-bit addressing: Set Destination Address (DL + DH) to match the Source Address (SL + SH) of the intended destination modem.

To send a packet to a specific modem using 16-bit addressing: Set DL (Destination Address Low) parameter to equal the MY parameter and set the DH (Destination Address High) parameter to '0'.

### 3.4.1. Unicast Mode

By default, the RF modem operates in Unicast Mode. Unicast Mode is the only mode that supports retries. While in this mode, receiving modems send an ACK (acknowledgement) of RF packet reception to the transmitter. If the transmitting modem does not receive the ACK, it will re-send the packet up to three times or until the ACK is received.

**Short 16-bit addresses.** The modem can be configured to use short 16-bit addresses as the Source Address by setting (MY < 0xFFFE). Setting the DH parameter (DH = 0) will configure the Destination Address to be a short 16-bit address (if DL < 0xFFFE). For two modems to communicate using short addressing, the Destination Address of the transmitter modem must match the MY parameter of the receiver.

The following table shows a sample network configuration that would enable Unicast Mode communications using short 16-bit addresses.

**Table 3-04. Sample Unicast Network Configuration (using 16-bit addressing)**

Parameter	RF Modem 1	RF Modem 2
MY (Source Address)	0x01	0x02
DH (Destination Address High)	0	0
DL (Destination Address Low)	0x02	0x01

**Long 64-bit addresses.** The RF modem's serial number (SL parameter concatenated to the SH parameter) can be used as a 64-bit source address when the MY (16-bit Source Address) parameter is disabled. When the MY parameter is disabled (set MY = 0xFFFF or 0xFFFE), the modem's source address is set to the 64-bit IEEE address stored in the SH and SL parameters.

When an End Device associates to a Coordinator, its MY parameter is set to 0xFFFE to enable 64-bit addressing. The 64-bit address of the modem is stored as SH and SL parameters. To send a packet to a specific modem, the Destination Address (DL + DH) on one modem must match the Source Address (SL + SH) of the other.

### 3.4.2. Broadcast Mode

Any RF modem within range will accept a packet that contains a broadcast address. When configured to operate in Broadcast Mode, receiving modems do not send ACKs (Acknowledgements) and transmitting modems do not automatically re-send packets as is the case in Unicast Mode.

To send a broadcast packet to all modems regardless of 16-bit or 64-bit addressing, set the destination addresses of all the modems as shown below.

Sample Network Configuration (All modems in the network):

- DL (Destination Low Address) = 0x0000FFFF
- DH (Destination High Address) = 0x00000000 (default value)

**NOTE:** When programming the modem, parameters are entered in hexadecimal notation (without the "0x" prefix). Leading zeros may be omitted.

## 4. RF Modem Configuration

### 4.1. Programming the RF Modem

Refer to the “Command Mode” section [p20] for more information about entering Command Mode, sending AT commands and exiting Command Mode. For information regarding modem programming using API Mode, refer to the “API Operation” sections [p43].

#### 4.1.1. Programming Examples

##### Setup

The programming examples in this section require the installation of MaxStream's X-CTU Software and a RS-232 connection to a PC.

1. Install MaxStream's X-CTU Software to a PC by double-clicking the "setup\_X-CTU.exe" file. (The file is located on the MaxStream CD and under the 'Software' section of the following web page: [www.maxstream.net/helpdesk/download.php](http://www.maxstream.net/helpdesk/download.php))
2. Connect the RF modem to a PC.
3. Launch the X-CTU Software and select the 'PC Settings' tab. Verify the baud and parity settings of the Com Port match those of the RF modem.

NOTE: Failure to enter AT Command Mode is most commonly due to baud rate mismatch. Ensure the 'Baud' setting on the 'PC Settings' tab matches the interface data rate of the RF modem (by default, BD parameter = 3 (which corresponds to 9600 bps)).

##### Sample Configuration: Modify RF Modem Destination Address

Example: Utilize the 'Terminal' tab of the X-CTU Software to change the RF modem's DL (Destination Address Low) parameter and save the new address to non-volatile memory.

After establishing a serial connection between the RF modem and a PC [refer to the 'Setup' section above], select the 'Terminal' tab of the X-CTU Software and enter the following command lines ('CR' stands for carriage return):

Method 1 (One line per command))

<b>Send AT Command</b>	<b>System Response</b>
+++	OK <CR> (Enter into Command Mode)
ATDL <Enter>	{current value} <CR> (Read Destination Address Low)
ATDL1AOD <Enter>	OK <CR> (Modify Destination Address Low)
ATWR <Enter>	OK <CR> (Write to non-volatile memory)
ATCN <Enter>	OK <CR> (Exit Command Mode)

Method 2 (Multiple commands on one line)

<b>Send AT Command</b>	<b>System Response</b>
+++	OK <CR> (Enter into Command Mode)
ATDL <Enter>	{current value} <CR> (Read Destination Address Low)
ATDL1AOD,WR,CN <Enter>	OK <CR> (Execute commands)

##### Sample Configuration: Restore RF Modem Defaults

Example: Utilize the 'Modem Configuration' tab of the X-CTU Software to restore default parameter values of the RF modem.

After establishing a connection between the RF modem and a PC [refer to the 'Setup' section above], select the 'Modem Configuration' tab of the X-CTU Software.

1. Select the 'Read' button.
2. Select the 'Restore' button.

## 4.2. Command Reference Tables

XBee-PRO RF Modems expect numerical values in hexadecimal. Hexadecimal values are designated by a “0x” prefix. Decimal equivalents are designated by a “d” suffix. Table rows are sorted by command category, then by logic of most commonly used.

All modems operating within the same network should contain the same firmware version.

### Special Commands

Table 4-01. XBee-PRO Commands - Special

AT Command	Command Category	Name and Description	Parameter Range	Default
FR	Special	<b>Software Reset.</b> Responds immediately with an OK then performs a hard reset ~100ms later.	-	-
RE	Special	<b>Restore Defaults.</b> Restore modem parameters to factory defaults.	-	-
WR	Special	<b>Write.</b> Write parameter values to non-volatile memory so that parameter modifications persist through subsequent power-up or reset. Note: Once WR is issued, no additional characters should be sent to the modem until after the response "OK\r" is received.	-	-

### Networking Commands

Table 4-02. XBee-PRO Commands - Networking (Sub-categories designated within {brackets})

AT Command	Command Category	Name and Description	Parameter Range	Default
CH	Networking {Addressing}	<b>Channel.</b> Set/Read the channel number used for transmitting and receiving between RF modems. Uses 802.15.4 protocol channel numbers.	0x0C - 0x17	0x0C (12d)
ID	Networking {Addressing}	<b>PAN ID.</b> Set/Read the PAN (Personal Area Network) ID. Use 0xFFFF to send messages to all PANs.	0xFFFF	0x3332 (13106d)
DH	Networking {Addressing}	<b>Destination Address High.</b> Set/Read the upper 32 bits of the 64-bit destination address. When combined with DL, it defines the destination address used for transmission. To transmit using a 16-bit address, set DH parameter to zero and DL less than 0xFFFF. 0x0000000000000000 is the broadcast address for the PAN.	0 - 0xFFFFFFFF	0
DL	Networking {Addressing}	<b>Destination Address Low.</b> Set/Read the lower 32 bits of the 64-bit destination address. When combined with DH, DL defines the destination address used for transmission. To transmit using a 16-bit address, set DH parameter to zero and DL less than 0xFFFF. 0x0000000000000000 is the broadcast address for the PAN.	0 - 0xFFFFFFFF	0
MY	Networking {Addressing}	<b>16-bit Source Address.</b> Set/Read the RF modem 16-bit source address. Set MY = 0xFFFF to disable reception of packets with 16-bit addresses. 64-bit source address (serial number) and broadcast address (0x0000000000000000) is always enabled.	0 - 0xFFFF	0
SH	Networking {Addressing}	<b>Serial Number High.</b> Read high 32 bits of the RF modem's unique IEEE 64-bit address. 64-bit source address is always enabled.	0 - 0xFFFFFFFF [read-only]	Factory-set
SL	Networking {Addressing}	<b>Serial Number Low.</b> Read low 32 bits of the RF modem's unique IEEE 64-bit address. 64-bit source address is always enabled.	0 - 0xFFFFFFFF [read-only]	Factory-set
RN	Networking {Addressing}	<b>Random Delay Slots.</b> Set/Read the minimum value of the back-off exponent in the CSMA-CA algorithm that is used for collision avoidance. If RN = 0, collision avoidance is disabled during the first iteration of the algorithm (802.15.4 - macMinBE).	0 - 3 [exponent]	0
MM	Networking {Addressing}	<b>MAC Mode.</b> Set/Read MAC Mode value. MAC Mode enables/disables the use of a MaxStream header in the 802.15.4 RF packet. When Mode 0 is enabled (MM=0), duplicate packet detection is enabled as well as certain AT commands. Modes 1 and 2 are strict 802.15.4 modes.	0 - 2	0
NI	Networking {Identification}	<b>Node Identifier.</b> Stores a string identifier. The register only accepts printable ASCII data. A string can not start with a space. Carriage return ends command. Command will automatically end when maximum bytes for the string have been entered. This string is returned as part of the ND (Node Discover) command. This identifier is also used with the DN (Destination Node) command.	20 byte ASCII string	-
ND	Networking {Identification}	<b>Node Discover.</b> Discovers and reports all RF modems found. The following information is reported for each modem discovered (refer to long command description regarding differences between Transparent and API operation). MY<CR> SH<CR> SL<CR> DB<CR> NI<CR><CR> After 2.5 seconds, the command ends by returning a <CR> (carriage return). ND also accepts a Modem Identifier as a parameter. In this case, only a modem matching the supplied identifier will respond.	optional 20 Byte NI value	

**Table 4-02. XBee-PRO Commands - Networking** (Sub-categories designated within [brackets])

AT Command	Command Category	Name and Description	Parameter Range	Default
DN	Networking {Identification}	<b>Destination Node.</b> Resolves a Modem Identifier string to a physical address. The following events occur upon successful command execution: 1. DL and DH are set to the address of the modem with the matching Modem Identifier. 2. "OK" is returned. 3. RF modem automatically exits AT Command Mode If there is no response from a modem within 200 msec or a parameter is not specified (left blank), the command is terminated and an "ERROR" message is returned.	20 byte ASCII string	
CE	Networking {Association}	<b>Coordinator Enable.</b> Set/Read the coordinator setting.	0 - 1 0 = End Device 1 = Coordinator	0
SC	Networking {Association}	<b>Scan Channel.</b> Set/Read list of channels to scan for all Active and Energy Scans as bit field. This affects scans initiated in command mode (AS, ED) and during End Device Association and Coordinator startup: bit 0 - 0x0B    bit 4 - 0x0F    bit 8 - 0x13    bit 12 - 0x17 bit 1 - 0x0C    bit 5 - 0x10    bit 9 - 0x14    bit 13 - 0x18 bit 2 - 0x0D    bit 6 - 0x11    bit 10 - 0x15    bit 14 - 0x19 bit 3 - 0x0E    bit 7 - 0x12    bit 11 - 0x16    bit 15 - 0x1A	0 - 0xFFFF (bit field) (bits 0, 14, 15 not allowed for XBee-PRO)	0x3FFE (all XBee-PRO Channels)
SD	Networking {Association}	<b>Scan Duration.</b> Set/Read the scan duration exponent. <b>End Device</b> - Duration of Active Scan during Association. On beacon system, set SD = BE of coordinator. SD must be set at least to the highest BE parameter of any Beaconing Coordinator with which an End Device or Coordinator wish to discover. <b>Coordinator</b> - If 'ReassignPANID' option is set on Coordinator [refer to A2 parameter], SD determines the length of time the Coordinator will scan channels to locate existing PANs. If 'ReassignChannel' option is set, SD determines how long the Coordinator will perform an Energy Scan to determine which channel it will operate on. 'Scan Time' is measured as (# of channels to scan) * (2 ^ SD) * 15.36ms). The number of channels to scan is set by the SC command. The XBee can scan up to 16 channels (SC = 0xFFFF). The XBee PRO can scan up to 12 channels (SC = 0x1FFE). Example: The values below show results for a 12-channel scan: If SD = 0, time = 0.18 sec    SD = 8, time = 47.19 sec SD = 2, time = 0.74 sec    SD = 10, time = 3.15 min SD = 4, time = 2.95 sec    SD = 12, time = 12.58 min SD = 6, time = 11.80 sec    SD = 14, time = 50.33 min	0-0x0F [exponent]	4
A1	Networking {Association}	<b>End Device Association.</b> Set/Read End Device association options. bit 0 - ReassignPanID 0 - Will only associate with Coordinator operating on PAN ID that matches modem ID 1 - May associate with Coordinator operating on any PAN ID bit 1 - ReassignChannel 0 - Will only associate with Coordinator operating on Channel that matches CH setting 1 - May associate with Coordinator operating on any Channel bit 2 - AutoAssociate 0 - Device will not attempt Association 1 - Device attempts Association until success Note: This bit is used only for Non-Beacon systems. End Devices in Beacon-enabled system must always associate to a Coordinator bit 3 - PollCoordOnPinWake 0 - Pin Wake will not poll the Coordinator for indirect (pending) data 1 - Pin Wake will send Poll Request to Coordinator to extract any pending data bits 4 - 7 are reserved	0 - 0x0F [bit field]	0
A2	Networking {Association}	<b>Coordinator Association.</b> Set/Read Coordinator association options. bit 0 - ReassignPanID 0 - Coordinator will not perform Active Scan to locate available PAN ID. It will operate on ID (PAN ID). 1 - Coordinator will perform Active Scan to determine an available ID (PAN ID). If a PAN ID conflict is found, the ID parameter will change. bit 1 - ReassignChannel - 0 - Coordinator will not perform Energy Scan to determine free channel. It will operate on the channel determined by the CH parameter. 1 - Coordinator will perform Energy Scan to find a free channel, then operate on that channel. bit 2 - AllowAssociation - 0 - Coordinator will not allow any devices to associate to it. 1 - Coordinator will allow devices to associate to it. bits 3 - 7 are reserved	0 - 7 [bit field]	6



**Table 4-02. XBee-PRO Commands - Networking** (Sub-categories designated within [brackets])

AT Command	Command Category	Name and Description	Parameter Range	Default
AI	Networking {Association}	<p><b>Association Indication.</b> Read errors with the last association request:</p> <p>0x00 - Successful Completion - Coordinator successfully started or End Device association complete</p> <p>0x01 - Active Scan Timeout</p> <p>0x02 - Active Scan found no PANs</p> <p>0x03 - Active Scan found PAN, but the CoordinatorAllowAssociation bit is not set</p> <p>0x04 - Active Scan found PAN, but Coordinator and End Device are not configured to support beacons</p> <p>0x05 - Active Scan found PAN, but the Coordinator ID parameter does not match the ID parameter of the End Device</p> <p>0x06 - Active Scan found PAN, but the Coordinator CH parameter does not match the CH parameter of the End Device</p> <p>0x07 - Energy Scan Timeout</p> <p>0x08 - Coordinator start request failed</p> <p>0x09 - Coordinator could not start due to invalid parameter</p> <p>0x0A - Coordinator Realignment is in progress</p> <p>0x0B - Association Request not sent</p> <p>0x0C - Association Request timed out - no reply was received</p> <p>0x0D - Association Request had an Invalid Parameter</p> <p>0x0E - Association Request Channel Access Failure. Request was not transmitted - CCA failure</p> <p>0x0F - Remote Coordinator did not send an ACK after Association Request was sent</p> <p>0x10 - Remote Coordinator did not reply to the Association Request, but an ACK was received after sending the request</p> <p>0x11 - [reserved]</p> <p>0x12 - Sync-Loss - Lost synchronization with a Beaconing Coordinator</p> <p>0x13 - Disassociated - No longer associated to Coordinator</p>	0 - 0x13 [read-only]	-
DA	Networking {Association}	<p><b>Force Disassociation.</b> End Device will immediately disassociate from a Coordinator (if associated) and reattempt to associate.</p>	-	-
FP	Networking {Association}	<p><b>Force Poll.</b> Request indirect messages being held by a coordinator.</p>	-	-
AS	Networking {Association}	<p><b>Active Scan.</b> Sends Beacon Request to Broadcast Address (0xFFFF) and Broadcast PAN (0xFFFF) on every channel. The parameter determines the time the radio will listen for Beacons on each channel. A PanDescriptor is created and returned for every Beacon received from the scan. Each PanDescriptor contains the following information:</p> <p>CoordAddress (SH, SL)&lt;CR&gt;</p> <p>CoordPanID (ID)&lt;CR&gt;</p> <p>CoordAddrMode &lt;CR&gt;</p> <p>    0x02 = 16-bit Short Address</p> <p>    0x03 = 64-bit Long Address</p> <p>Channel (CH parameter) &lt;CR&gt;</p> <p>SecurityUse&lt;CR&gt;</p> <p>ACLEntry&lt;CR&gt;</p> <p>SecurityFailure&lt;CR&gt;</p> <p>SuperFrameSpec&lt;CR&gt; (2 bytes):</p> <p>    bit 15 - Association Permitted (MSB)</p> <p>    bit 14 - PAN Coordinator</p> <p>    bit 13 - Reserved</p> <p>    bit 12 - Battery Life Extension</p> <p>    bits 8-11 - Final CAP Slot</p> <p>    bits 4-7 - Superframe Order</p> <p>    bits 0-3 - Beacon Order</p> <p>GtsPermit&lt;CR&gt;</p> <p>RSSI&lt;CR&gt; (RSSI is returned as -dBm)</p> <p>TimeStamp&lt;CR&gt; (3 bytes)</p> <p>&lt;CR&gt;</p> <p>A carriage return &lt;CR&gt; is sent at the end of the AS command. The Active Scan is capable of returning up to 5 PanDescriptors in a scan. The actual scan time on each channel is measured as Time = [(2 ^SD PARAM) * 15.36] ms. Note the total scan time is this time multiplied by the number of channels to be scanned (16 for the XBee and 13 for the XBee-PRO). Also refer to SD command description.</p>	0 - 6	-
ED	Networking {Association}	<p><b>Energy Scan.</b> Sends Energy Detect Scan. The parameter determines length of scan on each channel. The maximal energy on each channel is returned, each value is followed by a carriage return. An additional carriage return is sent at the end of the command. The values returned represent the detected energy level in units of -dBm. The actual scan time on each channel is measured as Time = [(2 ^ED) * 15.36] ms. Note the total scan time is this time multiplied by the number of channels to be scanned. Refer to SD parameter.</p>	0 - 6	-

**RF Interfacing Commands**

**Table 4-03. XBee/XBee-PRO Commands - RF Interfacing**

AT Command	Command Category	Name and Description	Parameter Range	Default
PL	RF Interfacing	<b>Power Level.</b> Select/Read the power level at which the RF modem transmits conducted power.	0 - 4	4
CA	RF Interfacing	<b>CCA Threshold.</b> Set/read the CCA (Clear Channel Assessment) threshold. Prior to transmitting a packet, a CCA is performed to detect energy on the channel. If the detected energy is above the CCA Threshold, the modem will not transmit the packet.	0 - 0x50 [-dBm]	0x2C (-44d dBm)

**Serial Interfacing Commands**

**Table 4-04. XBee-PRO Commands - Serial Interfacing**

AT Command	Command Category	Name and Description	Parameter Range	Default
BD	Serial Interfacing	<b>Interface Data Rate.</b> Set/Read the serial interface data rate for communications between the RF modem serial port and host.	0 - 7 (standard baud rates) 0 = 1200 bps 1 = 2400 2 = 4800 3 = 9600 4 = 19200 5 = 38400 6 = 57600 7 = 115200 0x80 - 0x1C200 (non-standard baud rates)	3
RO	Serial Interfacing	<b>Packetization Timeout.</b> Set/Read number of character times of inter-character delay required before transmission. Set to zero to transmit characters as they arrive instead of buffering them into one RF packet.	0 - 0xFF [x character times]	3
D7	Serial Interfacing	<b>DIO7 Configuration.</b> Select/Read options for the DIO7 line of the RF modem.	0 - 1 0 = Disabled 1 = CTS Flow Control	1
D6	Serial Interfacing	<b>DIO6 Configuration.</b> Select/Read options for the DIO6 line of the RF modem. Options include: RTS flow control.	0 - 1 0 = Disabled 1 = RTS flow control	0
D5	Serial Interfacing	<b>DIO5 Configuration.</b> Configure options for the DIO5 line of the RF modem. Options include: Associated LED indicator (blinks when associated).	0 - 1 0 = Disabled 1 = Associated indicator	1
P0	Serial Interfacing	<b>PWM0 Configuration.</b> Select/Read function for PWM0.	0 - 1 0 = Disabled 1 = RSSI	1
AP	Serial Interfacing	<b>API Enable.</b> Enable API Mode.	0 - 2 0 = Disabled 1 = API enabled 2 = API enabled (w/escaped control characters)	0
PR	Serial Interfacing	<b>Pull-up Resistor Enable.</b> Set/Read bitfield to configure internal pull-up resistor status for I/O lines. bit 0 - AD4/DIO4/RF_TX bit 1 - COORD bit 2 - AD2/DIO2 bit 3 - AD1/DIO1 bit 4 - AD0/DIO0 bit 5 - RTS bit 6 - SLEEP_RQ bit 7 - DIN/CONFIG "1" specifies pull-up enabled, "0" specifies no pull-up	0 - 0xFF	0xFF

**Sleep (Low Power) Commands**

**Table 4-05. XBee-PRO Commands - Sleep (Low Power)**

AT Command	Command Category	Name and Description	Parameter Range	Default
SM	Sleep (Low Power)	<b>Sleep Mode.</b> <NonBeacon firmware> Set/Read Sleep Mode configurations.	0 - 5 0 = No Sleep 1 = Pin Hibernate 2 = Pin Doze 3 = Reserved 4 = Cyclic sleep remote 5 = Cyclic sleep remote w/ pin wake-up 6 = [Sleep Coordinator - for backwards compatibility w/ v1.x6 only; otherwise, use CE command to enable a Coordinator.]	0
SP	Sleep (Low Power)	<b>Cyclic Sleep Period.</b> <NonBeacon firmware> Set/Read sleep period for cyclic sleeping remotes. Coordinator and End Device SP values should always be equal. To send Direct Messages, set SP = 0. <i>End Device</i> - SP determines the sleep period for cyclic sleeping remotes. Maximum sleep period is 268 seconds (0x68B0). <i>Coordinator</i> - If non-zero, SP determines the time to hold an indirect message before discarding it. A Coordinator will discard indirect messages after a period of (2.5 * SP).	0 - 0x68B0 [x 10 ms]	0
DP	Sleep (Low Power)	<b>Disassociated Cyclic Sleep Period.</b> <NonBeacon firmware> <i>End Device</i> - Set/Read time period of sleep for cyclic sleeping remotes that are configured for Association but are not associated to a Coordinator. (i.e. If a device is configured to associate, configured as a Cyclic Sleep remote, but does not find a Coordinator, it will sleep for DP time before reattempting association.) Maximum sleep period is 268 seconds (0x68B0). DP should be > 0 for NonBeacon systems.	1 - 0x68B0 [x 10 ms]	0x3E8 (1000d)
ST	Sleep (Low Power)	<b>Time before Sleep.</b> <NonBeacon firmware> Set/Read time period of inactivity (no serial or RF data is sent or received) before activating Sleep Mode. ST parameter is only valid with Cyclic Sleep settings (SM = 4 - 5). Coordinator and End Device ST values must be equal. Also note, the GT parameter value must always be less than the ST value. (If GT > ST, the configuration will render the modem unable to enter into command mode.) If the ST parameter is modified, also modify the GT parameter accordingly.	1 - 0xFFFF [x 1 ms]	0x1388 (5000d)

**Diagnostics Commands**

**Table 4-06. XBee-PRO Commands - Diagnostics**

AT Command	Command Category	Name and Description	Parameter Range	Default
EC	Diagnostics	<b>CCA Failures.</b> Reset/Read count of CCA (Clear Channel Assessment) failures. This parameter value increments when the modem does not transmit a packet because it detected energy above the CCA threshold level set with CA command. This count saturates at its maximum value. Set count to "0" to reset count.	0 - 0xFFFF	-
EA	Diagnostics	<b>ACK Failures.</b> Reset/Read count of acknowledgment failures. This parameter value increments when the modem expires its transmission retries without receiving an ACK on a packet transmission. This count saturates at its maximum value. Set the parameter to "0" to reset count.	0 - 0xFFFF	-
VR	Diagnostics	<b>Firmware Version.</b> Read firmware version of the RF modem.	0 - 0xFFFF [read-only]	Factory-set
VL	Diagnostics	<b>Firmware Version - Verbose.</b> Read detailed version information (including application build date, MAC, PHY and bootloader versions).	-	-
HV	Diagnostics	<b>Hardware Version.</b> Read hardware version of the RF modem.	0 - 0xFFFF [read-only]	Factory-set
RP	Diagnostics	<b>RSSI PWM Timer.</b> Enable a PWM (Pulse Width Modulation) output on pin 6 of the embedded OEM RF module which shows RX signal strength.	0 - 0xFF [x 100 ms]	0x28 (40d)
DB	Diagnostics	<b>Received Signal Strength.</b> Read signal level [in dB] of last good packet received (RSSI). Absolute value is reported. (For example: 0x58 = -88 dBm) Reported value is accurate between -40 dBm and RX sensitivity.	0 - 0x64 [read-only]	-
ED	Diagnostics	<b>Energy Scan.</b> Send an "Energy Detect Scan". This parameter determines the length of scan on each channel. The maximal energy on each channel is returned and each value is followed by a carriage return. The values returned represent the detected energy level in units of -dBm. The actual scan time on each channel is measured as Time = [(2 ^ SD PARAM) * 15.36]ms.	0 - 7	-

**AT Command Options Commands**

**Table 4-07. XBee-PRO Commands - AT Command Options**

AT Command	Command Category	Name and Description	Parameter Range	Default
CT	AT Command Mode Options	<b>Command Mode Timeout.</b> Set/Read the period of inactivity (no valid commands received) after which the RF modem automatically exits AT Command Mode and returns to Idle Mode.	2 - 0xFFFF [x 100 ms]	0x64 (100d)
CN	AT Command Mode Options	<b>Exit Command Mode.</b> Explicitly exit the modem from AT Command Mode.	--	--
AC	AT Command Mode Options	<b>Apply Changes.</b> Explicitly apply changes to queued parameter value(s) and re-initialize modem.	--	--
GT	AT Command Mode Options	<b>Guard Times.</b> Set required period of silence before and after the Command Sequence Characters of the AT Command Mode Sequence (GT+ CC + GT). The period of silence is used to prevent inadvertent entrance into AT Command Mode.	2 - 0xFFFF [x 1 ms]	0x3E8 (1000d)
CC	AT Command Mode Options	<b>Command Sequence Character.</b> Set/Read the ASCII character value to be used between Guard Times of the AT Command Mode Sequence (GT+CC+GT). The AT Command Mode Sequence enters the RF modem into AT Command Mode.	0 - 0xFF	0x2B ('+' ASCII)

## 4.3. Command Descriptions

Command descriptions in this section are listed alphabetically. Command categories are designated within "< >" symbols that follow each command title. XBee-PRO RF Modems expect parameter values in hexadecimal (designated by the "0x" prefix).

All modems operating within the same network should contain the same firmware version.

### A1 (End Device Association) Command

<Networking {Association}> The A1 command is used to set and read association options for and End Device.

Use the table below to determine End Device behavior in relation to the A1 parameter.

AT Command: ATA1

Parameter Range: 0 – 0x0F

Default Parameter Value: 0

Related Commands: ID (PAN ID), MI (Modem Identifier), CH (Channel), CE (Coordinator Enable), A2 (Coordinator Association)

Bit number	End Device Association Option
0 - ReassignPanID	0 - Will only associate with Coordinator operating on PAN ID that matches Modem Identifier 1 - May associate with Coordinator operating on any PAN ID
1 - ReassignChannel	0 - Will only associate with Coordinator operating on Channel that matches CH setting 1 - May associate with Coordinator operating on any Channel
2 - AutoAssociate	0 - Device will not attempt Association 1 - Device attempts Association until success Note: This bit is used only for Non-Beacon systems. End Devices in a Beaconsing system must always associate to a Coordinator
3 - PollCoordOnPinWake	0 - Pin Wake will not poll the Coordinator for pending (indirect) Data 1 - Pin Wake will send Poll Request to Coordinator to extract any pending data
4 - 7	[reserved]

### A2 (Coordinator Association) Command

<Networking {Association}> The A2 command is used to set and read association options of the Coordinator.

Use the table below to determine Coordinator behavior in relation to the A2 parameter.

AT Command: ATA2

Parameter Range: 0 – 0x07

Default Parameter Value: 0

Related Commands: ID (PAN ID), MI (Modem Identifier), CH (Channel), CE (Coordinator Enable), A1 (End Device Association), AS (Active Scan), ED (Energy Scan)

Bit number	End Device Association Option
0 - ReassignPanID	0 - Coordinator will not perform Active Scan to locate available PAN ID. It will operate on ID (PAN ID). 1 - Coordinator will perform Active Scan to determine an available ID (PAN ID). If a PAN ID conflict is found, the ID parameter will change.
1 - ReassignChannel	0 - Coordinator will not perform Energy Scan to determine free channel. It will operate on the channel determined by the CH parameter. 1 - Coordinator will perform Energy Scan to find a free channel, then operate on that channel.
2 - AllowAssociate	0 - Coordinator will not allow any devices to associate to it. 1 - Coordinator will allow devices to associate to it.
3 - 7	[reserved]

The binary equivalent of the default value (0x06) is 00000110. 'Bit 0' is the last digit of the sequence.

**AC (Apply Changes) Command**

<AT Command Mode Options> The AC command is used to explicitly apply changes to modem parameter values. 'Applying changes' means that the modem is re-initialized based on changes made to its parameter values. Once changes are applied, the modem immediately operates according to the new parameter values.

AT Command: ATAC

This behavior contrasts issuing the WR (Write) command. The WR command saves parameter values to non-volatile memory, but the modem still operates according to previously saved values until the modem is re-booted or the CN (Exit AT Command Mode) command is issued.

Refer to the "AT Command Queue" API type for more information [p45].

**AI (Association Indication) Command**

<Networking {Association}> The AI command is used to indicate occurrences of errors during the last association request.

AT Command: ATAI

Parameter Range: 0 – 0x13 [read-only]

Use the table below to determine meaning of the returned values.

Related Commands: AS (Active Scan), ID (PAN ID), CH (Channel), ED (Energy Scan), A1 (End Device Association), A2 (Coordinator Association), CE (Coordinator Enable)

Returned Value (Hex)	Association Indication
0x00	Successful Completion - Coordinator successfully started or End Device association complete
0x01	Active Scan Timeout
0x02	Active Scan found no PANs
0x03	Active Scan found PAN, but the Coordinator Allow Association bit is not set
0x04	Active Scan found PAN, but Coordinator and End Device are not configured to support beacons
0x05	Active Scan found PAN, but the Coordinator ID (PAN ID) parameter does not match the ID parameter of the End Device
0x06	Active Scan found PAN, but the Coordinator CH (Channel) parameter does not match the CH parameter of the End Device
0x07	Energy Scan Timeout
0x08	Coordinator start request failed
0x09	Coordinator could not start due to Invalid Parameter
0x0A	Coordinator Realignment is in progress
0x0B	Association Request not sent
0x0C	Association Request timed out - no reply was received
0x0D	Association Request had an Invalid Parameter
0x0E	Association Request Channel Access Failure - Request was not transmitted - CCA failure
0x0F	Remote Coordinator did not send an ACK after Association Request was sent
0x10	Remote Coordinator did not reply to the Association Request, but an ACK was received after sending the request
0x11	[reserved]
0x12	Sync-Loss - Lost synchronization with a Beaconing Coordinator
0x13	Disassociated - No longer associated to Coordinator

**AP (API Enable) Command**

<Serial Interfacing> The AP command is used to enable the RF modem to operate using frame-based API operation.

AT Command: ATAP

Parameter Range: 0 – 2

Parameter	Configuration
0	Disabled (UART operation)
1	API enabled
2	API enabled (with escaped characters)

Default Parameter Value: 0

Refer to the "API Operation" sections [p43] when API operation is enabled (AP = 1 or 2).

**AS (Active Scan) Command**

<AT Command Mode Options> The AS command is used to send a Beacon Request to a Broadcast Address (0xFFFF) and Broadcast PAN (0xFFFF) on every channel. The parameter determines the amount of time the RF modem will listen for Beacons on each channel. A 'PanDescriptor' is created and returned for every Beacon received from the scan. Each PanDescriptor contains the following information:

CoordAddress (SH + SL parameters)<CR>  
 CoordPanID (ID parameter)<CR>  
 CoordAddrMode <CR>  
     0x02 = 16-bit Short Address  
     0x03 = 64-bit Long Address  
 Channel (CH parameter) <CR>  
 SecurityUse<CR>  
 ACLEntry<CR>  
 SecurityFailure<CR>  
 SuperFrameSpec<CR> (2 bytes):  
     bit 15 - Association Permitted (MSB)  
     bit 14 - PAN Coordinator  
     bit 13 - Reserved  
     bit 12 - Battery Life Extension  
     bits 8-11 - Final CAP Slot  
     bits 4-7 - Superframe Order  
     bits 0-3 - Beacon Order  
 GtsPermit<CR>  
 RSSI<CR> (- RSSI is returned as -dBm)  
 TimeStamp<CR> (3 bytes)  
 <CR> (A carriage return <CR> is sent at the end of the AS command.

AT Command: ATAS

Parameter Range: 0 – 6 (bit field)

Related Command: SD (Scan Duration), DL (Destination Low Address), DH (Destination High Address), ID (PAN ID), CH (Channel)

The Active Scan is capable of returning up to 5 PanDescriptors in a scan. The actual scan time on each channel is measured as Time = [(2 ^ (SD Parameter)) \* 15.36] ms. Total scan time is this time multiplied by the number of channels to be scanned (16 for the XBee, 13 for the XBee-PRO).

NOTES: Refer the scan table in the SD description [p40] to determine scan times. If using API Mode, no <CR>'s are returned in the response (Refer to the API Mode Operation section [p43]).

**BD (Interface Data Rate) Command**

<Serial Interfacing> The BD command is used to set and read the serial interface data rate (baud rate) used between the RF modem and host. This parameter determines the rate at which serial data is sent to the modem from the host. Modified interface data rates do not take effect until the CN (Exit AT Command Mode) command is issued and the system returns the 'OK' response.

When parameters 0-7 are sent to the modem, the respective interface data rates are used (as shown in the table on the right).

The RF data rate is not affected by the BD parameter. If the interface data rate is set higher than the RF data rate, a flow control configuration may need to be implemented.

Command description is continued on the next page.

AT Command: ATBD

Parameter Range: 0 – 7 (standard rates)  
 0x80-0x1C200 (non-stdnd rates)

Parameter	Configuration (bps)
0	1200
1	2400
2	4800
3	9600
4	19200
5	38400
6	57600
7	115200

Default Parameter Value:3

**Non-standard Interface Data Rates:**

When parameter values outside the range of standard baud rates are sent, the closest interface data rate represented by the number is stored in the BD register. For example, a rate of 19200 bps can be set by sending the following command line "ATBD4B00". NOTE: When using MaxStream's X-CTU Software, non-standard interface data rates can only be set and read using the X-CTU 'Terminal' tab. Non-standard rates are not accessible through the 'Modem Configuration' tab.

When the BD command is sent with a non-standard interface data rate, the UART will adjust to accommodate the requested interface rate. In most cases, the clock resolution will cause the stored BD parameter to vary from the parameter that was sent (refer to the table below). Reading the BD command (send "ATBD" command without an associated parameter value) will return the value that was actually stored to the BD register.

**Parameters Sent Versus Parameters Stored**

BD Parameter Sent (HEX)	Interface Data Rate (bps)	BD Parameter Stored (HEX)
0	1200	0
4	19,200	4
7	115,200	7
12C	300	12B
1C200	115,200	1B207

**CA (CCA Threshold) Command**

<RF Interfacing> CA command is used to set and read CCA (Clear Channel Assessment) thresholds. Prior to transmitting a packet, a CCA is performed to detect energy on the transmit channel. If the detected energy is above the CCA Threshold, the RF modem will not transmit the packet.

AT Command: ATCA

Parameter Range: 0 – 0x50 [-dBm]

Default Parameter Value: 0x2C  
(-44 dBm (decimal))

**CC (Command Sequence Character) Command**

<AT Command Mode Options> The CC command is used to set and read the ASCII character used between guard times of the AT Command Mode Sequence (GT + CC + GT). This sequence enters the RF modem into AT Command Mode so that data entering the modem from the host is recognized as commands instead of payload.

AT Command: ATCC

Parameter Range: 0 – 0xFF

Default Parameter Value: 0x2B (ASCII "+")

Related Command: GT (Guard Times)

The AT Command Sequence is discussed further in the AT Command Mode section [p20].

**CE (Coordinator Enable) Command**

<Serial Interfacing> The CE command is used to set and read the behavior (End Device vs. Coordinator) of the RF modem.

AT Command: ATCE

Parameter Range: 0 – 1

Parameter	Configuration
0	End Device
1	Coordinator

Default Parameter Value: 0



**CH (Channel) Command**

<Networking {Addressing}> The CH command is used to set and read the channel on which RF connections are made between RF modems. The channel is one of three filtration options available to the modem. The other options are the PAN ID (ID command) and destination addresses (DL & DH commands).

In order for modems to communicate with each other, the modems must share the same channel number. Different channels can be used to prevent modems in one network from listening to transmissions of another.

The modem uses channel numbers of the 802.15.4 standard.

$$\text{Center Frequency} = 2.405 + (\text{CH} - 11d) * 5 \text{ MHz} \quad (d = \text{decimal})$$

AT Command: ATCH

Parameter Range: 0x0C – 0x17

Default Parameter Value: 0x0C (12 decimal)

Related Commands: ID (PAN ID), DL (Destination Address Low, DH (Destination Address High)

Refer to the “Addressing” section [p21] for more information.

**CN (Exit AT Command Mode) Command**

<AT Command Mode Options> The CN command is used to explicitly exit the RF modem from AT Command Mode.

AT Command: ATCN

**CT (Command Mode Timeout) Command**

<AT Command Mode Options> The CT command is used to set and read the amount of inactive time that elapses before the RF modem automatically exits from AT Command Mode and returns to Idle Mode.

Use the CN (Exit AT Command Mode) command to exit AT Command Mode manually.

AT Command: ATCT

Parameter Range: 2 – 0xFFFF  
[x 100 milliseconds]

Default Parameter Value: 0x64 (100 decimal (which equals 10 decimal seconds))

Number of bytes returned: 2

Related Command: CN (Exit AT Command Mode)

**D5 (DIO5 Configuration) Command**

<Serial Interfacing> The D5 command is used to configure options for the DIO5 line of the RF modem. When the D5 parameter is set to “1”, the D5 line is used to indicate “Association (membership with another modem)” by causing the LED indicator to blink.

AT Command: ATD5

Parameter Range: 0 – 1

Parameter	Configuration
0	Disabled
1	Association Indicator

Default Parameter Value: 1

**D6 (DIO6 Configuration) Command**

<Serial Interfacing> The D6 command is used to set and read the behavior of the DIO6 line. This line can be configured to enable RTS flow control.

AT Command: ATD6

Parameter Range: 0 – 1

Parameter	Configuration
0	Disabled
1	RTS Flow Control

Default Parameter Value: 0

### D7 (DIO7 Configuration) Command

<Serial Interfacing> The D7 command is used to set and read the behavior of the DIO7 line. CTS flow control is enabled by default.

AT Command: ATD7

Parameter Range: 0 – 1

Parameter	Configuration
0	Disabled
1	CTS Flow Control

Default Parameter Value: 1

### DA (Force Disassociation) Command

<(Special)> The DA command is used to immediately disassociate an End Device from a Coordinator and reattempt to associate.

AT Command: ATDA

### DB (Received Signal Strength) Command

<Diagnostics> DB parameter is used to read the received signal strength (in dBm) of the last RF packet received. Reported values are accurate between -40 dBm and the RF modem's receiver sensitivity.

AT Command: ATDB

Parameter Range: 0 – 0x64 [read-only]

Absolute values are reported. For example: 0x58 = -88 dBm (decimal). If no packets have been received (since last reset, power cycle or sleep event), "0" will be reported.

### DH (Destination Address High) Command

<Networking {Addressing}> The DH command is used to set and read the upper 32 bits of the RF modem's 64-bit destination address. When combined with the DL (Destination Address Low) parameter, it defines the destination address used for transmission.

AT Command: ATDH

Parameter Range: 0 – 0xFFFFFFFF

Default Parameter Value: 0

Related Commands: DL (Destination Address Low), CH (Channel), ID (PAN VID), MY (Source Address)

An modem will only communicate with other modems having the same channel (CH parameter), PAN ID (ID parameter) and destination address (DH + DL parameters).

To transmit using a 16-bit address, set the DH parameter to zero and the DL parameter less than 0xFFFF. 0x00000000000000FFFF (DL concatenated to DH) is the broadcast address for the PAN.

Refer to the "Addressing" section [p21] for more information.

### DL (Destination Address Low) Command

<Networking {Addressing}> The DL command is used to set and read the lower 32 bits of the RF modem's 64-bit destination address. When combined with the DH (Destination Address High) parameter, it defines the destination address used for transmission.

AT Command: ATDL

Parameter Range: 0 - 0xFFFFFFFF

Default Parameter Value: 0

Related Commands: DH (Destination Address High), CH (Channel), ID (PAN VID), MY (Source Address)

A modem will only communicate with other modems having the same channel (CH parameter), PAN ID (ID parameter) and destination address (DH + DL parameters).

To transmit using a 16-bit address, set the DH parameter to zero and the DL parameter less than 0xFFFF. 0x00000000000000FFFF (DL concatenated to DH) is the broadcast address for the PAN.

Refer to the "Addressing" section [p21] for more information.

**DN (Destination Node) Command**

<Networking { Identification} > The DN command is used to resolve a NI (Node Identifier) string to a physical address. The following events occur upon successful command execution:

1. DL and DH are set to the address of the modem with the matching NI (Node Identifier).
2. 'OK' is returned.
3. RF modem automatically exits AT Command Mode.

If there is no response from a modem within 200 msec or a parameter is not specified (left blank), the command is terminated and an 'ERROR' message is returned.

AT Command: ATDN

Parameter Range: 20 Byte ASCII String

**DP (Disassociation Cyclic Sleep Period) Command**

<Sleep Mode (Low Power) >

**NonBeacon Firmware**

*End Device* - The DP command is used to set and read the time period of sleep for cyclic sleeping remotes that are configured for Association but are not associated to a Coordinator. (i.e. If a device is configured to associate, configured as a Cyclic Sleep remote, but does not find a Coordinator; it will sleep for DP time before reattempting association.) Maximum sleep period is 268 seconds (0x68B0).

DP should be > 0 for NonBeacon systems.

AT Command: ATDP

Parameter Range:	NonBeacon Firmware: 1 – 0x68B0 [x 10 milliseconds]
------------------	---

Default Parameter Value:	NonBeacon Firmware: 0x3E8 (1000 decimal)
--------------------------	---

Related Commands: SM (Sleep Mode), SP (Cyclic Sleep Period), ST (Time before Sleep)

**EA (ACK Failures) Command**

<Diagnostics> The EA command is used to reset and read the count of ACK (acknowledgement) failures. This parameter value increments when the modem expires its transmission retries without receiving an ACK on a packet transmission. This count saturates at its maximum value. Set the parameter to "0" to reset count.

AT Command: ATEA

Parameter Range: 0 – 0xFFFF

**EC (CCA Failures) Command**

<Diagnostics> The EC command is used to read and reset the count of CCA (Clear Channel Assessment) failures. This parameter value increments when the RF modem does not transmit a packet due to the detection of energy that is above the CCA threshold level (set with CA command). This count saturates at its maximum value. Set the EC parameter to "0" to reset count.

AT Command: ATEC

Parameter Range: 0 – 0xFFFF

Related Command: CA (CCA Threshold)

**ED (Energy Scan) Command**

<Networking { Association} > The ED command is used to send an "Energy Detect Scan". This parameter determines the length of scan on each channel. The maximal energy on each channel is returned and each value is followed by a carriage return. An additional carriage return is sent at the end of the command.

The values returned represent the detected energy level in units of -dBm. The actual scan time on each channel is measured as  $Time = [(2 \wedge ED \text{ PARAM}) * 15.36] \text{ ms}$ .

AT Command: ATED

Parameter Range: 0 – 6

Related Command: SD (Scan Duration), SC (Scan Channel)

Note: Total scan time is this time multiplied by the number of channels to be scanned. Also refer to the SD (Scan Duration) table. Use the SC (Scan Channel) command to choose which channels to scan.

**FP (Force Poll) Command**

<(Special)> The FP command is used to request indirect messages being held by a coordinator.

AT Command: ATFP

**FR (Software Reset) Command**

<(Special)> The FR command is used to force a software reset on the RF modem. The reset simulates powering off and then on again the modem.

AT Command: ATFR

**GT (Guard Times) Command**

<AT Command Mode Options> GT Command is used to set the DI (data in from host) time-of-silence that surrounds the AT command sequence character (CC Command) of the AT Command Mode sequence (GT + CC + GT).

The DI time-of-silence is used to prevent inadvertent entrance into AT Command Mode.

AT Command: ATGT

Parameter Range: 2 – 0xFFFF  
[x 1 millisecond]

Default Parameter Value: 0x3E8  
(1000 decimal)

Related Command: CC (Command Sequence Character)

**HV (Hardware Version) Command**

<Diagnostics> The HV command is used to read the hardware version of the RF modem.

AT Command: ATHV

Parameter Range: 0 – 0xFFFF [Read-only]

**ID (Pan ID) Command**

<Networking {Addressing}> The ID command is used to set and read the PAN (Personal Area Network) ID of the RF modem. Only modems with matching PAN IDs can communicate with each other. Unique PAN IDs enable control of which RF packets are received by a modem.

Setting the ID parameter to 0xFFFF indicates a global transmission for all PANs. It does not indicate a global receive.

AT Command: ATID

Parameter Range: 0 – 0xFFFF

Default Parameter Value: 0x3332  
(13106 decimal)

**MM (MAC Mode) Command**

<Networking {Addressing}> The MM command is used to set and read the MAC Mode value. MAC Mode disable/enables the use of a MaxStream header contained in the 802.15.4 RF packet. When enabled (Mode 0, MM = 0) duplicate packet detection is enabled as well as certain AT commands. Modes 1 and 2 are strict 802.15.4 modes. When the MaxStream header is disabled, the ND (Node Discover) and DN (Destination Node) parameters are also disabled.

AT Command: ATMM

Parameter Range: 0 – 2

Parameter	Configuration
0	MaxStream Mode (802.15.4 + MaxStream header)
1	802.15.4 (no ACKs)
2	802.15.4 (with ACKs)

Default Parameter Value: 0

**MY (16-bit Source Address) Command**

<Networking {Addressing}> The MY command is used to set and read the 16-bit source address of the RF modem.

By setting MY to 0xFFFF, the reception of RF packets having a 16-bit address is disabled. The 64-bit address is the modem's serial number and is always enabled.

Refer to the Addressing section [p21] for more information.

AT Command: ATMY

Parameter Range: 0 – 0xFFFF

Default Parameter Value: 0

Related Commands: DH (Destination Address High), DL (Destination Address Low), CH (Channel), ID (PAN ID)

**ND (Node Discover) Command**

<Networking {Identification}> The ND command is used to discover and report all RF modems on its current CH (channel) and ID (Pan ID). ND also accepts an NI (Node Identifier) value as a parameter. In this case, only a modem matching the supplied identifier will respond.

The ND command causes a modem to transmit a globally addressed ND command packet. This modem will allow responses within a 2.5 second window. The 2.5 second window is large enough to receive all responses.

In AT Command mode, command completion is designated by a carriage return (0x0D). Since two carriage returns end a command response, the application will receive three carriage returns at the end of the command. If no responses are received, the application should only receive one carriage return. When in API mode, the application should receive a frame (with no data) and status (set to 'OK') at the end of the command. When the ND command packet is received, the remote sets up a random time delay of 2.5 seconds before replying with a ND response as follows:

Node Discover Response (AT command mode format):

MY (Source Address) value<CR>  
 SH (Serial Number High) value<CR>  
 SL (Serial Number Low) value<CR>  
 DB (Received Signal Strength) value<CR>  
 NI (Node Identifier) value<CR>  
 <CR> (This is part of the response and not the end of command indicator.)

Node Discover Response (API format - data is binary (except for MI)):

2 bytes for MY (Source Address) value  
 4 bytes for SH (Serial Number High) value  
 4 bytes for SL (Serial Number Low) value  
 1 byte for RS (Received Signal Strength) value  
 NULL-terminated string for NI (Node Identifier) value (max 20 bytes w/out NULL terminator)

AT Command: ATND

Parameter Range: optional 20 byte NI value (decimal)

Related Commands: CH (Channel), ID (Pan ID), MY (Source Address), SH (Serial Number High), SL (Serial Number Low), NI (Node Identifier)

**NI (Node Identifier) Command**

<Networking {Identification}> The NI command is used to set and read a string for identifying a particular node.

Rules:

- Register only accepts printable ASCII data.
- A string can not start with a space.
- A carriage return ends command
- Command will automatically end when maximum bytes for the string have been entered.

This string is returned as part of the ND (Node Discover) command. This identifier is also used with the DN (Destination Node) command.

AT Command: ATNI

Parameter Range: 20 Byte ASCII string (decimal)

Related Commands: ND (Node Discover), DN (Destination Node)

**P0 (PWM0 Configuration) Command**

<Diagnostics> The P0 command is used to select and read the function for PWM0 (Pulse Width Modulation Output 0).

Note: The second character in the command is a zero ("0"), not the letter "O".

AT Command: ATP0

Parameter Range: 0 – 1

Parameter	Configuration
0	Disabled
1	RSSI PWM0 enabled

Default Parameter Value: 1

**PL (Power Level) Command**

<RF Interfacing> The PL command is used to select and read the power level at which the RF modem transmits conducted power.

WHEN OPERATING IN EUROPE:  
 XBee-PRO RF Modems must be configured to operate at a maximum transmit power output level of 10 dBm. The PL parameter must equal "0" (10 dBm).

Additionally, European regulations stipulate an EIRP power maximum of 12.86 dBm (19 mW) for the XBee-PRO and 12.11 dBm for the XBee when integrating high-gain antennas.

AT Command: ATPL

Parameter Range: 0 – 4

Parameter	XBee	XBee-Pro
0	-10 dBm	10 dBm
1	-6 dBm	12 dBm
2	-4 dBm	14 dBm
3	-2 dBm	16 dBm
4	0 dBm	18 dBm

Default Parameter Value: 4

**PR (Pull-up Resistor Enable) Command**

<Serial Interfacing> The PR command is used to set and read the bit field that is used to configure internal the pull-up resistor status for I/O lines. "1" specifies the pull-up resistor is enabled. "0" specifies no pull up.

- bit 0 - AD4/DIO4/RF\_TX
- bit 1 - COORD
- bit 2 - AD2/DIO2
- bit 3 - AD1/DIO1
- bit 4 - AD0/DIO0
- bit 5 - RTS
- bit 6 - SLEEP\_RQ
- bit 7 - DIN/CONFIG

For example: Sending the command "ATPR 6F" will turn bits 0, 1, 2, 3, 5 and 6 ON; and bits 4 & 7 will be turned OFF. (The binary equivalent of "0x6F" is "01101111". Note that 'bit 0' is the last digit in the bitfield.

AT Command: ATPR

Parameter Range: 0 – 0xFF

Default Parameter Value: 0xFF (all pull-up resistors are enabled)

**RE (Restore Defaults) Command**

<(Special)> The RE command is used to restore all configurable parameters to their factory default settings. The RE command does not write restored values to non-volatile (persistent) memory. Issue the WR (Write) command subsequent to issuing the RE command to save restored parameter values to non-volatile memory.

AT Command: ATRE

**RN (Random Delay Slots) Command**

<Networking & Security> The RN command is used to set and read the minimum value of the back-off exponent in the CSMA-CA algorithm. The CSMA-CA algorithm was engineered for collision avoidance (random delays are inserted to prevent data loss caused by data collisions).

If RN = 0, collision avoidance is disabled during the first iteration of the algorithm (802.15.4 - macMinBE).

CSMA-CA stands for "Carrier Sense Multiple Access - Collision Avoidance". Unlike CSMA-CD (reacts to network transmissions after collisions have been detected), CSMA-CA acts to prevent data collisions before they occur. As soon as a modem receives a packet that is to be transmitted, it checks if the channel is clear (no other modem is transmitting). If the channel is clear, the packet is sent over-the-air. If the channel is not clear, the modem waits for a randomly selected period of time, then checks again to see if the channel is clear. After a time, the process ends and the data is lost.

AT Command: ATRN  
 Parameter Range: 0 – 3 [exponent]  
 Default Parameter Value: 0

**RO (Packetization Timeout) Command**

<Serial Interfacing> RO command is used to set and read the number of character times of inter-character delay required before transmission.

RF transmission commences when data is detected in the DI (data in from host) buffer and RO character times of silence are detected on the UART receive lines (after receiving at least 1 byte).

RF transmission will also commence after 100 bytes (maximum packet size) are received in the DI buffer.

Set the RO parameter to '0' to transmit characters as they arrive instead of buffering them into one RF packet.

AT Command: ATRO  
 Parameter Range: 0 – 0xFF  
 [x character times]  
 Default Parameter Value: 3

**RP (RSSI PWM Timer) Command**

<Diagnostics> The RP command is used to enable PWM (Pulse Width Modulation) output on the RF modem. The output is calibrated to show the level a received RF signal is above the sensitivity level of the modem. The PWM pulses vary from zero to 95 percent. Zero to twenty-nine percent means the received RF signal is at or below the published sensitivity level of the modem. The following table shows levels above sensitivity and PWM values.

The total period of the PWM output is 8.32 ms. Because there are 40 steps in the PWM output, the minimum step size is 0.208 ms.

**PWM Percentages**

dB above Sensitivity	PWM percentage* (high period / total period)
10	46.0%
20	63.0%
30	80.1%

\* PWM% = (295 + (17.5 \* dBm above sensitivity)) / 10.24

A non-zero value defines the time that the PWM output will be active with the RSSI value of the last received RF packet. After the set time when no RF packets are received, the PWM output will be set low (0 percent PWM) until another RF packet is received. The PWM output will also be set low at power-up until the first RF packet is received. A parameter value of 0xFF permanently enables the PWM output and it will always reflect the value of the last received RF packet.

AT Command: ATRP  
 Parameter Range: 0 – 0xFF  
 [x 100 milliseconds]  
 Default Parameter Value: 0x28 (40 decimal)

### SC (Scan Channel) Command

<RF Interfacing> The SC command is used to set and read the list of channels to scan for all Active and Energy Scans as a bit field.

This affects scans initiated in command mode [AS (Active Scan) and ED (Energy Scan) commands] and during End Device Association and Coordinator startup:

bit 0 - 0x0B	bit 4 - 0x0F	bit 8 - 0x13	bit 12 - 0x17
bit 1 - 0x0C	bit 5 - 0x10	bit 9 - 0x14	bit 13 - 0x18
bit 2 - 0x0D	bit 6 - 0x11	bit 10 - 0x15	bit 14 - 0x19
bit 3 - 0x0E	bit 7 - 0x12	bit 11 - 0x16	bit 15 - 0x1A

AT Command: ATSC

Parameter Range: 0 – 0xFFFF [Bit Field]

Default Parameter Value: 0x1FFE (all XBee-PRO channels)

Related Commands: ED (Energy Scan), SD (Scan Duration)

### SD (Scan Duration) Command

<Networking {Association}> The SD command is used to set and read the exponent value that determines the duration (in time) of a scan.

**End Device** (Duration of Active Scan during Association) - In a Beacon system, set SD = BE of the Coordinator. SD must be set at least to the highest BE parameter of any Beaconsing Coordinator with which an End Device or Coordinator wish to discover.

**Coordinator** - If the 'ReassignPANID' option is set on the Coordinator [refer to A2 parameter], the SD parameter determines the length of time the Coordinator will scan channels to locate existing PANs. If the 'ReassignChannel' option is set, SD determines how long the Coordinator will perform an Energy Scan to determine which channel it will operate on.

Scan Time is measured as ((# of Channels to Scan) \* (2 ^ SD) \* 15.36ms). The number of channels to scan is set by the SC command. The XBee RF Modem can scan up to 16 channels (SC = 0xFFFF). The XBee PRO RF Modem can scan up to 12 channels (SC = 0x1FFE).

**Examples: Values below show results for a 12-channel scan**

If SD = 0, time = 0.18 sec	SD = 8, time = 47.19 sec
SD = 2, time = 0.74 sec	SD = 10, time = 3.15 min
SD = 4, time = 2.95 sec	SD = 12, time = 12.58 min
SD = 6, time = 11.80 sec	SD = 14, time = 50.33 min

AT Command: ATSD

Parameter Range: 0 – 0x0F

Default Parameter Value: 4

Related Commands: ED (Energy Scan), SC (Scan Channel)

### SH (Serial Number High) Command

<Diagnostics> The SH command is used to read the high 32 bits of the RF modem's unique IEEE 64-bit address.

The modem serial number is set at the factory and is read-only.

AT Command: ATSH

Parameter Range: 0 – 0xFFFFFFFF [read-only]

Related Commands: SL (Serial Number Low), MY (Source Address)

### SL (Serial Number Low) Command

<Diagnostics> The SL command is used to read the low 32 bits of the RF modem's unique IEEE 64-bit address.

The modem serial number is set at the factory and is read-only.

AT Command: ATSL

Parameter Range: 0 – 0xFFFFFFFF [read-only]

Related Commands: SH (Serial Number High), MY (Source Address)



**SM (Sleep Mode) Command**

<Sleep Mode (Low Power)> The SM command is used to set and read Sleep Mode settings. By default, Sleep Modes are disabled (SM = 0) and the RF modem remains in Idle/Receive Mode. When in this state, the modem is constantly ready to respond to either serial or RF activity.

SM command options vary according to the networking system type. By default, the modem is configured to operate in a NonBeacon system.

\* The Sleep Coordinator option (SM=6) only exists for backwards compatibility with firmware version 1.x06 only. In all other cases, use the CE command to enable a Coordinator.

AT Command: ATSM

Parameter Range: 0 – 6

Parameter	Configuration
0	Disabled
1	Pin Hibernate
2	Pin Doze
3	(reserved)
4	Cyclic Sleep Remote
4	Cyclic Sleep Remote (with Pin Wake-up)
6	Sleep Coordinator*

Default Parameter Value: 0

Related Commands: SP (Cyclic Sleep Period), ST (Time before Sleep)

**SP (Cyclic Sleep Period) Command**

<Sleep Mode (Low Power)> The SP command is used to set and read the duration of time in which a remote RF modem sleeps. After the cyclic sleep period is over, the modem wakes and checks for data. If data is not present, the modem goes back to sleep. The maximum sleep period is 268 seconds (SP = 0x68B0).

The SP parameter is only valid if the modem is configured to operate in Cyclic Sleep (SM = 4-6). Coordinator and End Device SP values should always be equal.

To send Direct Messages, set SP = 0.

**NonBeacon Firmware**

*End Device* - SP determines the sleep period for cyclic sleeping remotes. Maximum sleep period is 268 seconds (0x68B0).

*Coordinator* - If non-zero, SP determines the time to hold an indirect message before discarding it. A Coordinator will discard indirect messages after a period of (2.5 \* SP).

AT Command: ATSP

Parameter Range: NonBeacon Firmware: 1 – 0x68B0 [x 10 milliseconds]

Default Parameter Value: NonBeacon Firmware: 0

Related Commands: SM (Sleep Mode), ST (Time before Sleep), DP (Disassociation Cyclic Sleep Period, BE (Beacon Order)

**ST (Time before Sleep) Command**

<Sleep Mode (Low Power)> The ST command is used to set and read the period of inactivity (no serial or RF data is sent or received) before activating Sleep Mode.

**NonBeacon Firmware**

Set/Read time period of inactivity (no serial or RF data is sent or received) before activating Sleep Mode. ST parameter is only valid with Cyclic Sleep settings (SM = 4 - 5).

Coordinator and End Device ST values must be equal.

AT Command: ATST

Parameter Range: NonBeacon Firmware: 1 – 0xFFFF [x 1 millisecond]

Default Parameter Value: NonBeacon Firmware: 0x1388 (5000 decimal)

Related Commands: SM (Sleep Mode), ST (Time before Sleep)

**VL (Firmware Version - Verbose)**

<Diagnostics> The VL command is used to read detailed version information about the RF modem. The information includes: application build date; MAC, PHY and bootloader versions; and build dates.

AT Command: ATVL

Parameter Range: 0 – 0xFF [x 100 milliseconds]

Default Parameter Value: 0x28 (40 decimal)

### **VR (Firmware Version) Command**

---

<Diagnostics> The VR command is used to read which firmware version is stored in the modem.

AT Command: ATVR

Parameter Range: 0 – 0xFFFF [read only]

---

XBee version numbers will have four significant digits. The reported number will show three or four numbers and is stated in hexadecimal notation. A version can be reported as "ABC" or "ABCD". Digits ABC are the main release number and D is the revision number from the main release. "D" is not required and if it is not present, a zero is assumed for D. "B" is a variant designator. The following variants exist:

- "0" - Non-Beacon Enabled 802.15.4 Code
- "1" - Beacon Enabled 802.15.4 Code

### **WR (Write) Command**

---

<(Special)> The WR command is used to write configurable parameters to the RF modem's non-volatile memory. Parameter values remain in the modem's memory until overwritten by subsequent use of the WR Command.

AT Command: ATWR

---

If changes are made without writing them to non-volatile memory, the modem reverts back to previously saved parameters the next time the modem is powered-on.

---

NOTE: Once the WR command is sent to the modem, no additional characters should be sent until after the "OK/r" response is received.

---

## 4.4. API Operation

By default, XBee-PRO RF Modems act as a serial line replacement (Transparent Operation) - all UART data received through the DI pin is queued up for RF transmission. When the modem receives an RF packet, the data is sent out the DO pin with no additional information.

Inherent to Transparent Operation are the following behaviors:

- If modem parameter registers are to be set or queried, a special operation is required for transitioning the modem into Command Mode [refer to p20].
- In point-to-multipoint systems, the application must send extra information so that the receiving modem(s) can distinguish between data coming from different remotes.

As an alternative to the default Transparent Operation, API (Application Programming Interface) Operations are available. API operation requires that communication with the modem be done through a structured interface (data is communicated in frames in a defined order). The API specifies how commands, command responses and modem status messages are sent and received from the modem using a UART Data Frame.

### 4.4.1. API Frame Specifications

Two API modes are supported and both can be enabled using the AP (API Enable) command. Use the following AP parameter values to configure the modem to operate in a particular mode:

- AP = 0 (default): Transparent Operation (UART Serial line replacement)  
API modes are disabled.
- AP = 1: API Operation
- AP = 2: API Operation (with escaped characters)

Any data received prior to the start delimiter is silently discarded. If the frame is not received correctly or if the checksum fails, the data is silently discarded.

#### API Operation (AP parameter = 1)

When this API mode is enabled (AP = 1), the UART data frame structure is defined as follows:

Figure 4-01. UART Data Frame Structure:



MSB = Most Significant Byte, LSB = Least Significant Byte

#### API Operation - with Escape Characters (AP parameter = 2)

When this API mode is enabled (AP = 2), the UART data frame structure is defined as follows:

Figure 4-02. UART Data Frame Structure - with escape control characters:

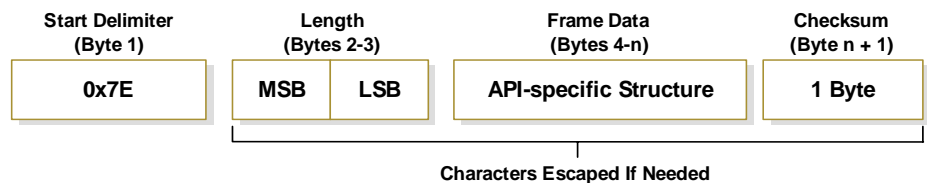

MSB = Most Significant Byte, LSB = Least Significant Byte

**Escape characters.** When sending or receiving a UART data frame, specific data values must be escaped (flagged) so they do not interfere with the UART or UART data frame operation. To escape an interfering data byte, insert 0x7D and follow it with the byte to be escaped XOR'd with 0x20.

**Data bytes that need to be escaped:**

- 0x7E – Frame Delimiter
- 0x7D – Escape
- 0x11 – XON
- 0x13 – XOFF

**Example** - Raw UART Data Frame (before escaping interfering bytes):  
 0x7E 0x00 0x02 0x23 0x11 0xCB  
 0x11 needs to be escaped which results in the following frame:  
 0x7E 0x00 0x02 0x23 0x7D 0x31 0xCB

Note: In the above example, the length of the raw data (excluding the checksum) is 0x0002 and the checksum of the non-escaped data (excluding frame delimiter and length) is calculated as:  
 $0xFF - (0x23 + 0x11) = (0xFF - 0x34) = 0xCB$ .

**Checksum**

To test data integrity, a checksum is calculated and verified on non-escaped data.

**To calculate:** Not including frame delimiters and length, add all bytes keeping only the lowest 8 bits of the result and subtract from 0xFF.

**To verify:** Add all bytes (include checksum, but not the delimiter and length). If the checksum is correct, the sum will equal 0xFF.

**4.4.2. API Types**

Frame data of the UART data frame forms an API-specific structure as follows:

Figure 4-03. UART Data Frame & API-specific Structure:

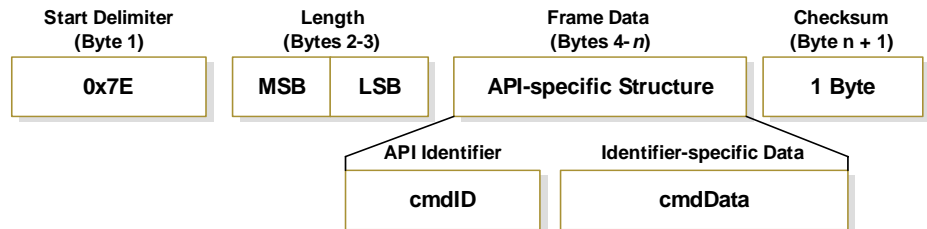

The cmdID frame (API-identifier) indicates which API messages will be contained in the cmdData frame (Identifier-specific data). Refer to the sections that follow for more information regarding the supported API types. Note that multi-byte values are sent big endian.

**Modem Status**

API Identifier: 0x8A

RF modem status messages are sent from the modem in response to specific conditions.

Figure 4-04. Modem Status Frames

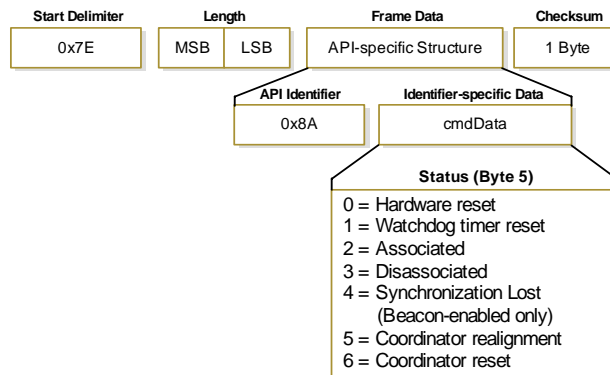

**AT Command**

API Identifier Value: 0x08

The “AT Command” API type allows for modem parameters to be queried or set. When using this command ID, new parameter values are applied immediately. This includes any register set with the “AT Command - Queue Parameter Value” (0x09) API type.

**Figure 4-05. AT Command Frames**

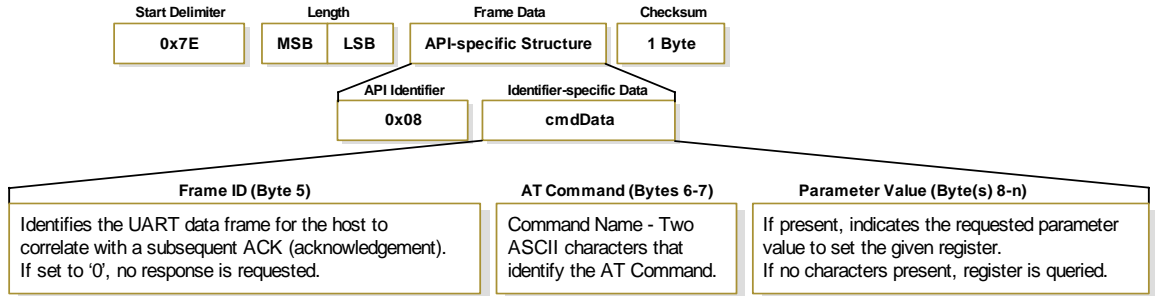

**Figure 4-06. Example: API frames when reading the DL parameter value of the modem.**

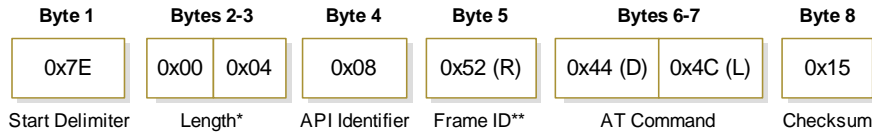

\* Length [Bytes] = API Identifier + Frame ID + AT Command

\*\* "R" value was arbitrarily selected.

**Figure 4-07. Example: API frames when modifying the DL parameter value of the modem.**

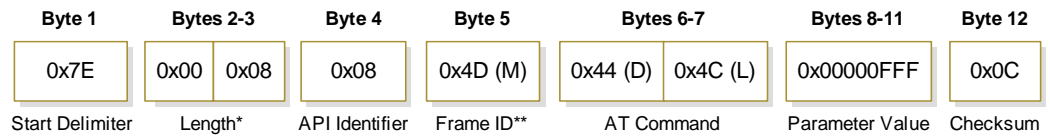

\* Length [Bytes] = API Identifier + Frame ID + AT Command + Parameter Value

\*\* "M" value was arbitrarily selected.

**AT Command - Queue Parameter Value**

API Identifier Value: 0x09

This API type allows modem parameters to be queried or set. In contrast to the “AT Command” API type, new parameter values are queued and not applied until either the “AT Command” (0x08) API type or the AC (Apply Changes) command is issued. Register queries (reading parameter values) are returned immediately.

**Figure 4-08. AT Command Frames**

(Note that frames are identical to the “AT Command” API type except for the API identifier.)

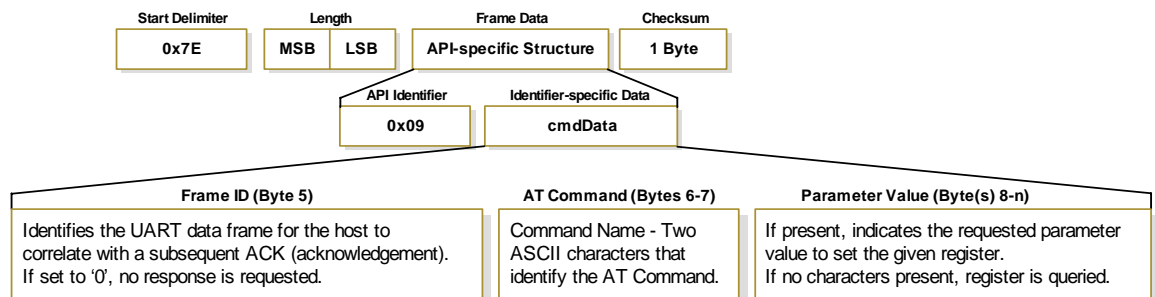

### AT Command Response

API Identifier Value: 0x88  
 Response to previous command.

In response to an AT Command message, the modem will send an AT Command Response message. Some commands will send back multiple frames (for example, the ND (Node Discover) and AS (Active Scan) commands). These commands will end by sending a frame with a status of ATCMD\_OK and no cmdData.

Figure 4-09. AT Command Response Frames.

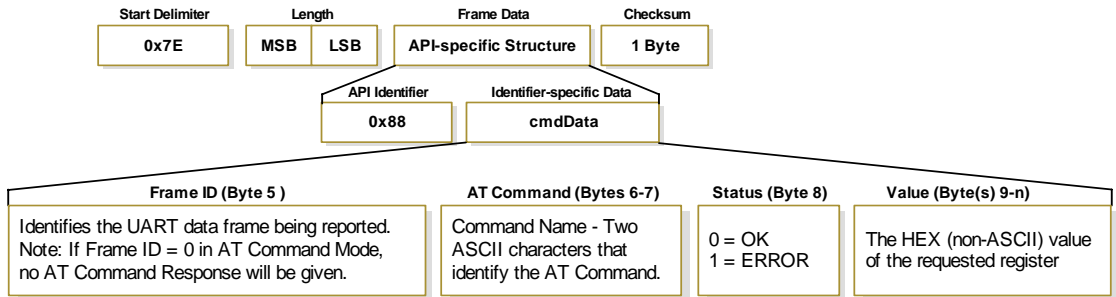

### TX (Transmit) Request: 64-bit address

API Identifier Value: 0x00  
 A TX Request message will cause the modem to send RF Data as an RF Packet.

Figure 4-10. TX Packet (64-bit address) Frames

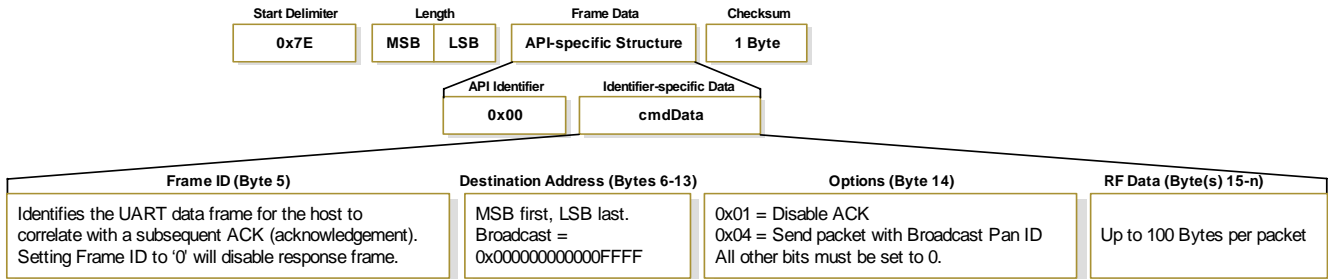

### TX (Transmit) Request: 16-bit address

API Identifier Value: 0x01  
 A TX Request message will cause the modem to send RF Data as an RF Packet.

Figure 4-11. TX Packet (16-bit address) Frames

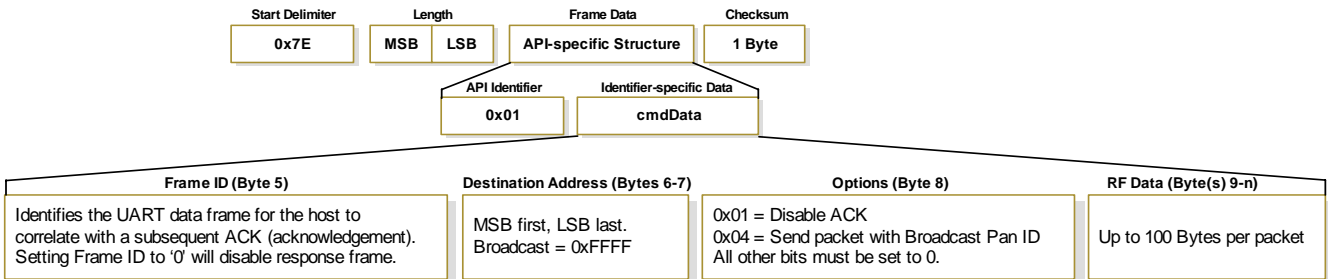

### TX (Transmit) Status

API Identifier Value: 0x89

When a TX Request is completed, the modem sends a TX Status message. This message will indicate if the packet was transmitted successfully or if there was a failure.

Figure 4-12. TX Status Frames

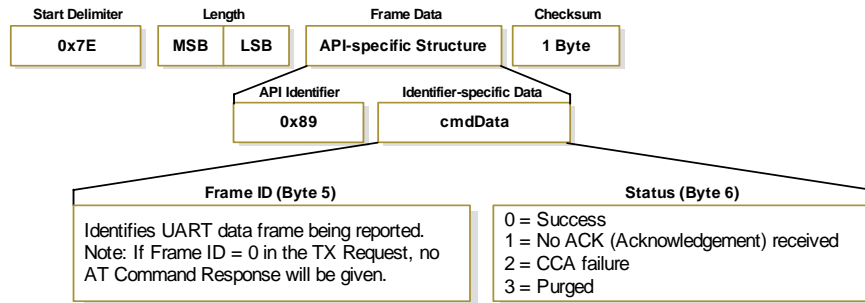

NOTES:

- "STATUS = 1" occurs when all retries are expired and no ACK is received.
- If transmitter broadcasts (destination address = 0x000000000000FFFF), only "STATUS = 0 or 2" will be returned.
- "STATUS = 3" occurs when Coordinator times out of an indirect transmission. Timeout is defined as (2.5 x SP (Cyclic Sleep Period) parameter value).

### RX (Receive) Packet: 64-bit address

API Identifier Value: 0x80

When the modem receives an RF packet, it is sent out the UART using this message type.

Figure 4-13. RX Packet (64-bit address) Frames

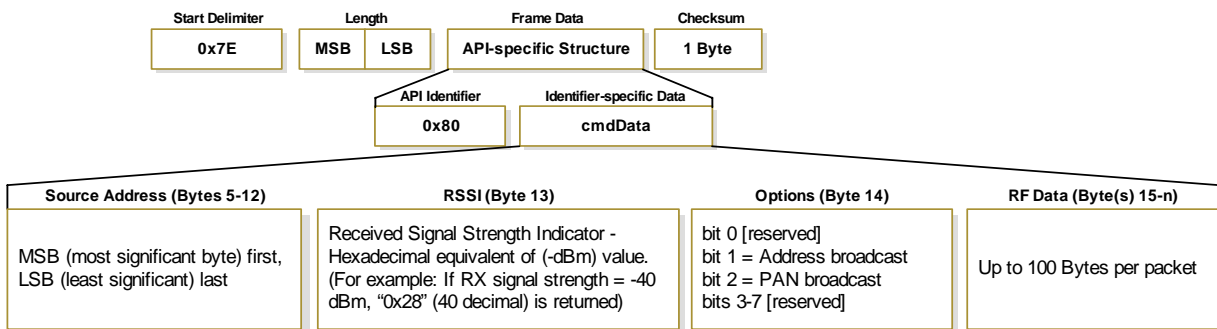

### RX (Receive) Packet: 16-bit address

API Identifier Value: 0x81

When the modem receives an RF packet, it is sent out the UART using this message type.

Figure 4-14. RX Packet (16-bit address) Frames

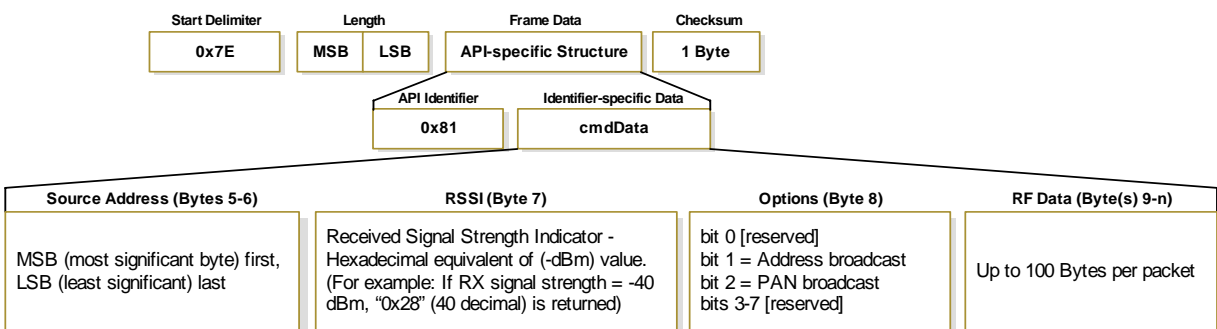

# Appendix A: Agency Certifications

## FCC Certification

XBee-PRO RF Modems comply with Part 15 of the FCC rules and regulations. Compliance with the labeling requirements, FCC notices and antenna usage guidelines is required.

To fulfill FCC Certification requirements, the OEM must comply with the following regulations:

1. The system integrator must ensure that the text on the external label provided with this device is placed on the outside of the final product [Figure A-01].
2. XBee-PRO RF Modems may only be used with antennas that have been tested and approved for use with this modem.

## OEM Labeling Requirements



**WARNING:** The Original Equipment Manufacturer (OEM) must ensure that FCC labeling requirements are met. This includes a clearly visible label on the outside of the final product enclosure that displays the contents shown in the figure below.

**Figure A-01. Required FCC Label for OEM products containing the XBee-PRO RF Modem**

Contains FCC ID: OUR-XBEEPRO

The enclosed device complies with Part 15 of the FCC Rules. Operation is subject to the following two conditions: (i) this device may not cause harmful interference and (ii) this device must accept any interference received, including interference that may cause undesired operation.

## FCC Notices

**IMPORTANT:** The XBee-PRO RS-232 RF Modem has been certified by the FCC for use with other products without any further certification (as per FCC section 2.1091). Modifications not expressly approved by MaxStream could void the user's authority to operate the equipment.

**IMPORTANT:** OEMs must test final product to comply with unintentional radiators (FCC section 15.107 & 15.109) before declaring compliance of their final product to Part 15 of the FCC Rules.

**IMPORTANT:** The RF modem has been certified for remote and base radio applications. If the modem will be used for portable applications, the device must undergo SAR testing.

This equipment has been tested and found to comply with the limits for a Class B digital device, pursuant to Part 15 of the FCC Rules. These limits are designed to provide reasonable protection against harmful interference in a residential installation. This equipment generates, uses and can radiate radio frequency energy and, if not installed and used in accordance with the instructions, may cause harmful interference to radio communications. However, there is no guarantee that interference will not occur in a particular installation.

If this equipment does cause harmful interference to radio or television reception, which can be determined by turning the equipment off and on, the user is encouraged to try to correct the interference by one or more of the following measures: Re-orient or relocate the receiving antenna, Increase the separation between the equipment and receiver, Connect equipment and receiver to outlets on different circuits, or Consult the dealer or an experienced radio/TV technician for help.



## FCC-Approved Antennas (2.4 GHz)

The XBee-PRO RF Modem can be installed utilizing antennas and cables constructed with standard connectors (Type-N, SMA, TNC, etc.) if the installation is performed professionally and according to FCC guidelines. For installations not performed by a professional, non-standard connectors (RPSMA, RPTNC, etc.) must be used.

The modems are FCC approved for fixed base station and mobile applications on channels 0x0B - 0x17. If the antenna is mounted at least 20cm (8 in.) from nearby persons, the application is considered a mobile application. Antennas not listed in the table must be tested to comply with FCC Section 15.203 (Unique Antenna Connectors) and Section 15.247 (Emissions).

**Table A-01. Antennas approved for use with the XBee-PRO RF Modems - Cable-loss is not required**

Part Number	Type (Description)	Gain	Application*	Min. Separation
A24-HSM-450	Dipole (Half-wave articulated RPSMA - 4.5")	2.1 dBi	Fixed/Mobile	20 cm
A24-HABSM	Dipole (Articulated RPSMA)	2.1 dBi	Fixed	20 cm
A24-HABUF-P5I	Dipole (Half-wave articulated bulkhead mount U.F.L. w/ 5" pigtail)	2.1 dBi	Fixed	20 cm
A24-QI	Monopole (Integrated whip)	1.5 dBi	Fixed	20 cm

**Table A-02. Antennas approved for use with the XBee-PRO RF Modems - Cable-loss is required**

Part Number	Type (Description)	Gain	Application*	Min. Separation	Required Cable-loss
A24-C1	Surface Mount	-1.5 dBi	Fixed/Mobile	20 cm	-
A24-Y4NF	Yagi (4-element)	6.0 dBi	Fixed	2 m	8.1 dB
A24-Y6NF	Yagi (6-element)	8.8 dBi	Fixed	2 m	10.9 dB
A24-Y7NF	Yagi (7-element)	9.0 dBi	Fixed	2 m	11.1 dB
A24-Y9NF	Yagi (9-element)	10.0 dBi	Fixed	2 m	12.1 dB
A24-Y10NF	Yagi (10-element)	11.0 dBi	Fixed	2 m	13.1 dB
A24-Y12NF	Yagi (12-element)	12.0 dBi	Fixed	2 m	14.1 dB
A24-Y13NF	Yagi (13-element)	12.0 dBi	Fixed	2 m	14.1 dB
A24-Y15NF	Yagi (15-element)	12.5 dBi	Fixed	2 m	14.6 dB
A24-Y16NF	Yagi (16-element)	13.5 dBi	Fixed	2 m	15.6 dB
A24-Y16RM	Yagi (16-element, RPSMA connector)	13.5 dBi	Fixed	2 m	15.6 dB
A24-Y18NF	Yagi (18-element)	15.0 dBi	Fixed	2 m	17.1 dB
A24-F2NF	Omni-directional (Fiberglass base station)	2.1 dBi	Fixed/Mobile	20 cm	4.2 dB
A24-F3NF	Omni-directional (Fiberglass base station)	3.0 dBi	Fixed/Mobile	20 cm	5.1 dB
A24-F5NF	Omni-directional (Fiberglass base station)	5.0 dBi	Fixed/Mobile	20 cm	7.1 dB
A24-F8NF	Omni-directional (Fiberglass base station)	8.0 dBi	Fixed	2 m	10.1 dB
A24-F9NF	Omni-directional (Fiberglass base station)	9.5 dBi	Fixed	2 m	11.6 dB
A24-F10NF	Omni-directional (Fiberglass base station)	10.0 dBi	Fixed	2 m	12.1 dB
A24-F12NF	Omni-directional (Fiberglass base station)	12.0 dBi	Fixed	2 m	14.1 dB
A24-F15NF	Omni-directional (Fiberglass base station)	15.0 dBi	Fixed	2 m	17.1 dB
A24-W7NF	Omni-directional (Base station)	7.2 dBi	Fixed	2 m	9.3 dB
A24-M7NF	Omni-directional (Mag-mount base station)	7.2 dBi	Fixed	2 m	9.3 dB
A24-P8SF	Flat Panel	8.5 dBi	Fixed	2 m	8.6 dB
A24-P8NF	Flat Panel	8.5 dBi	Fixed	2 m	8.6 dB
A24-P13NF	Flat Panel	13.0 dBi	Fixed	2 m	13.1 dB
A24-P14NF	Flat Panel	14.0 dBi	Fixed	2 m	14.1 dB
A24-P15NF	Flat Panel	15.0 dBi	Fixed	2 m	15.1 dB
A24-P16NF	Flat Panel	16.0 dBi	Fixed	2 m	16.1 dB
A24-P19NF	Flat Panel	19.0 dBi	Fixed	2 m	19.1 dB

\* **If using the RF modem in a portable application** (For example - If the modem is used in a handheld device and the antenna is less than 20cm from the human body when the device is operation): The integrator is responsible for passing additional SAR (Specific Absorption Rate) testing based on FCC rules 2.1091 and FCC Guidelines for Human Exposure to Radio Frequency Electromagnetic Fields, OET Bulletin and Supplement C. The testing results will be submitted to the FCC for approval prior to selling the integrated unit. The required SAR testing measures emissions from the modem and how they affect the person.

### RF Exposure



**WARNING:** To satisfy FCC RF exposure requirements for mobile transmitting devices, a separation distance of 20 cm or more should be maintained between the antenna of this device and persons during device operation. To ensure compliance, operations at closer than this distance is not recommended. The antenna used for this transmitter must not be co-located in conjunction with any other antenna or transmitter.

The preceding statement must be included as a CAUTION statement in OEM product manuals in order to alert users of FCC RF Exposure compliance.

## European Certification

The XBee-PRO RF Modem has been certified for use in several European countries. For a complete list, refer to [www.maxstream.net](http://www.maxstream.net).

If the XBee-PRO RF Modems are incorporated into a product, the manufacturer must ensure compliance of the final product to the European harmonized EMC and low-voltage/safety standards. A Declaration of Conformity must be issued for each of these standards and kept on file as described in Annex II of the R&TTE Directive.

Furthermore, the manufacturer must maintain a copy of the XBee-PRO user manual documentation and ensure the final product does not exceed the specified power ratings, antenna specifications, and/or installation requirements as specified in the user manual. If any of these specifications are exceeded in the final product, a submission must be made to a notified body for compliance testing to all required standards.

## OEM Labeling Requirements

The 'CE' marking must be affixed to a visible location on the OEM product.

Figure A-02. CE Labeling Requirements



The CE mark shall consist of the initials "CE" taking the following form:

- If the CE marking is reduced or enlarged, the proportions given in the above graduated drawing must be respected.
- The CE marking must have a height of at least 5mm except where this is not possible on account of the nature of the apparatus.
- The CE marking must be affixed visibly, legibly, and indelibly.

## Restrictions

**Power Output:** The power output of the XBee-PRO RF Modems must not exceed 10 dBm. The power level is set using the PL command and the PL parameter must equal "0" (10 dBm).

**France:** France imposes restrictions on the 2.4 GHz band. Go to [www.art-telecom.fr](http://www.art-telecom.fr) or contact MaxStream for more information.

**Norway:** Norway prohibits operation near Ny-Alesund in Svalbard. More information can be found at the Norway Posts and Telecommunications site ([www.npt.no](http://www.npt.no)).

## Declarations of Conformity

MaxStream has issued Declarations of Conformity for the XBee-PRO RF Modems concerning emissions, EMC and safety. Files are located in the 'documentation' folder of the MaxStream CD.

### Important Note

MaxStream does not list the entire set of standards that must be met for each country. MaxStream customers assume full responsibility for learning and meeting the required guidelines for each country in their distribution market. For more information relating to European compliance of an OEM product incorporating the XBee-PRO RF Modem, contact MaxStream, or refer to the following web sites:

CEPT ERC 70-03E - Technical Requirements, European restrictions and general requirements: Available at [www.ero.dk/](http://www.ero.dk/).

R&TTE Directive - Equipment requirements, placement on market: Available at [www.ero.dk/](http://www.ero.dk/).

## **Approved Antennas**

---

When integrating high-gain antennas, European regulations stipulate EIRP power maximums. Use the following guidelines to determine which antennas to design into an application.

**XBee-PRO** (@ 10 dBm Transmit Power, PL parameter value must equal 0)

---

The following antennas have been tested and approved for use with the embedded XBee-PRO RF Module:

- Dipole (2.1 dBi, Articulated RPSMA, MaxStream part number A24-HABSM)
- Chip Antenna (-1.5 dBi)
- Attached Monopole Whip (1.5 dBi)

The RF modem encasement was designed to accommodate the RPSMA antenna option.

## **IC (Industry Canada) Certification**

---

### **Labeling Requirements**

---

Labeling requirements for Industry Canada are similar to those of the FCC. A clearly visible label on the outside of the final product enclosure must display the following text:

**Contains Model XBee-PRO Radio, IC: 4214A XBEEPRO**

The integrator is responsible for its product to comply with IC ICES-003 & FCC Part 15, Sub. B - Unintentional Radiators. ICES-003 is the same as FCC Part 15 Sub. B and Industry Canada accepts FCC test report or CISPR 22 test report for compliance with ICES-003.

# Appendix B: Additional Information

## 1-Year Warranty

XBee-PRO RF Modems from MaxStream, Inc. (the "Product") are warranted against defects in materials and workmanship under normal use, for a period of 1-year from the date of purchase. In the event of a product failure due to materials or workmanship, MaxStream will repair or replace the defective product. For warranty service, return the defective product to MaxStream, shipping prepaid, for prompt repair or replacement.

The foregoing sets forth the full extent of MaxStream's warranties regarding the Product. Repair or replacement at MaxStream's option is the exclusive remedy. THIS WARRANTY IS GIVEN IN LIEU OF ALL OTHER WARRANTIES, EXPRESS OR IMPLIED, AND MAXSTREAM SPECIFICALLY DISCLAIMS ALL WARRANTIES OF MERCHANTABILITY OR FITNESS FOR A PARTICULAR PURPOSE. IN NO EVENT SHALL MAXSTREAM, ITS SUPPLIERS OR LICENSORS BE LIABLE FOR DAMAGES IN EXCESS OF THE PURCHASE PRICE OF THE PRODUCT, FOR ANY LOSS OF USE, LOSS OF TIME, INCONVENIENCE, COMMERCIAL LOSS, LOST PROFITS OR SAVINGS, OR OTHER INCIDENTAL, SPECIAL OR CONSEQUENTIAL DAMAGES ARISING OUT OF THE USE OR INABILITY TO USE THE PRODUCT, TO THE FULL EXTENT SUCH MAY BE DISCLAIMED BY LAW. SOME STATES DO NOT ALLOW THE EXCLUSION OR LIMITATION OF INCIDENTAL OR CONSEQUENTIAL DAMAGES. THEREFORE, THE FOREGOING EXCLUSIONS MAY NOT APPLY IN ALL CASES. This warranty provides specific legal rights. Other rights which vary from state to state may also apply.

## Ordering Information

Figure B-01. Divisions of the XBee-PRO RF Modem Part Numbers

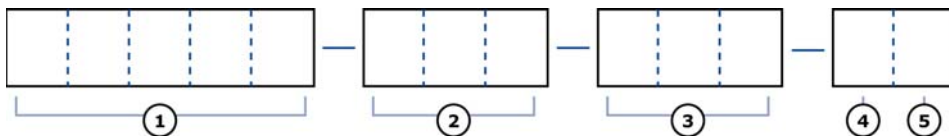

① **Product Family**  
XBP24 = XBee-PRO 2.4 GHz

② **Temperature Rating**  
PKC = Commercial (0 to 70° C)  
PKI = Industrial (-40 to 85° C)  
PKD = Class I, Division 2

③ **Protocol**  
001 = 802.15.4  
002 = ZigBee

④ **Interface**  
R = RS-232  
U = USB

⑤ **Accessories Package**  
A = Accessories package (specific to Interface) included  
(blank) means the accessories package is not included

For example:

XBP24-PKI-001-RA = XBee-PRO RF Modem (2.4 GHz), Industrial temperature rating, IEEE 802.15.4 standard, RS-232 Interface w/ accessories

## **Contact MaxStream**

---

Free and unlimited technical support is included with every MaxStream Radio Modem sold. For the best in wireless data solutions and support, please use the following resources:

Documentation: [www.maxstream.net/support/downloads.php](http://www.maxstream.net/support/downloads.php)

Technical Support: Phone. (866) 765-9885 toll-free U.S.A. & Canada  
(801) 765-9885 Worldwide

Live Chat. [www.maxstream.net](http://www.maxstream.net)

E-Mail. [rf-xperts@maxstream.net](mailto:rf-xperts@maxstream.net)

MaxStream office hours are 8:00 am - 5:00 pm [U.S. Mountain Standard Time]