

# SPECIFICATION FOR COLOR STN LCD MODULE

MODEL NO: TM128128CKFWG32-9

CUSTOMER: \_\_\_\_\_

TIANMA MICROELETRONIC CO., LTD  
22/F HANGDU BUILDING, CATIC ZONE,  
SHEN NAN ROAD CENTRAL  
SHENZHEN, CHINA  
TEL: (86-755) 83790774  
FAX: (86-755) 83790431  
WEB: WWW.TIANMA.COM



PREPARED	CHECKED	VERIFIED BY R&D DEPT	VERIFIED BY QC DEPT	APPROVED

## REVISION RECORD

Date	Rev.No.	Revision Items	Prepared	Checked	Approved
<b>2006.2.8</b>	<b>V1.0</b>	<b>NEW</b>			

# CONTENTS

	<b>Page</b>
1. General Specifications -----	1
2. Outline Drawing -----	2
3. Circuit Block Diagram -----	3
4. Absolute Maximum Ratings -----	4
5. Electrical Specifications and Instruction Code -----	5
6. Optical Characteristics -----	10
7. Reliability -----	14
8. Quality level-----	15
9. Precautions for Use of LCD Modules -----	19

## 1.General Specifications

Item	Contents	Unit	Note
LCD Type	Color STN	-	
Display color	65K		1
LCD Duty	1/128	-	
LCD Bias	1/5	-	
Viewing Direction	6:00	O'Clock	
Viewing Area(W×H)	28.3×30.17	mm	
Active Area(W×H)	26.1×28.15	mm	
Number of Dots	128(RGB)×128	mm	
Dote Size(W×H)	0.192×0.210	mm	
Dot Pitch(W×H)	0.204×0.220	mm	
Controller	S6B33B6	-	
V <sub>DD</sub>	3.0	V	
V <sub>op</sub>	10.6	V	
Outline Dimensions	Refer to outline drawing on next page		
Backlight	LED(white)	-	
Operating Temperature	-20~+70℃	-	
Storage Temperature	-30~+80℃	-	
Weight	TBD	g	2
Data Transfer	16 bits parallel	-	
Polarizer Mode	Transmissive/Negative	-	

Note 1: Color tune is slightly changed by temperature and driving voltage.

Note 2: TBD- To Be Determined.

Note: Requirements on Environmental Protection:RoHS

## 2. Outline Drawing

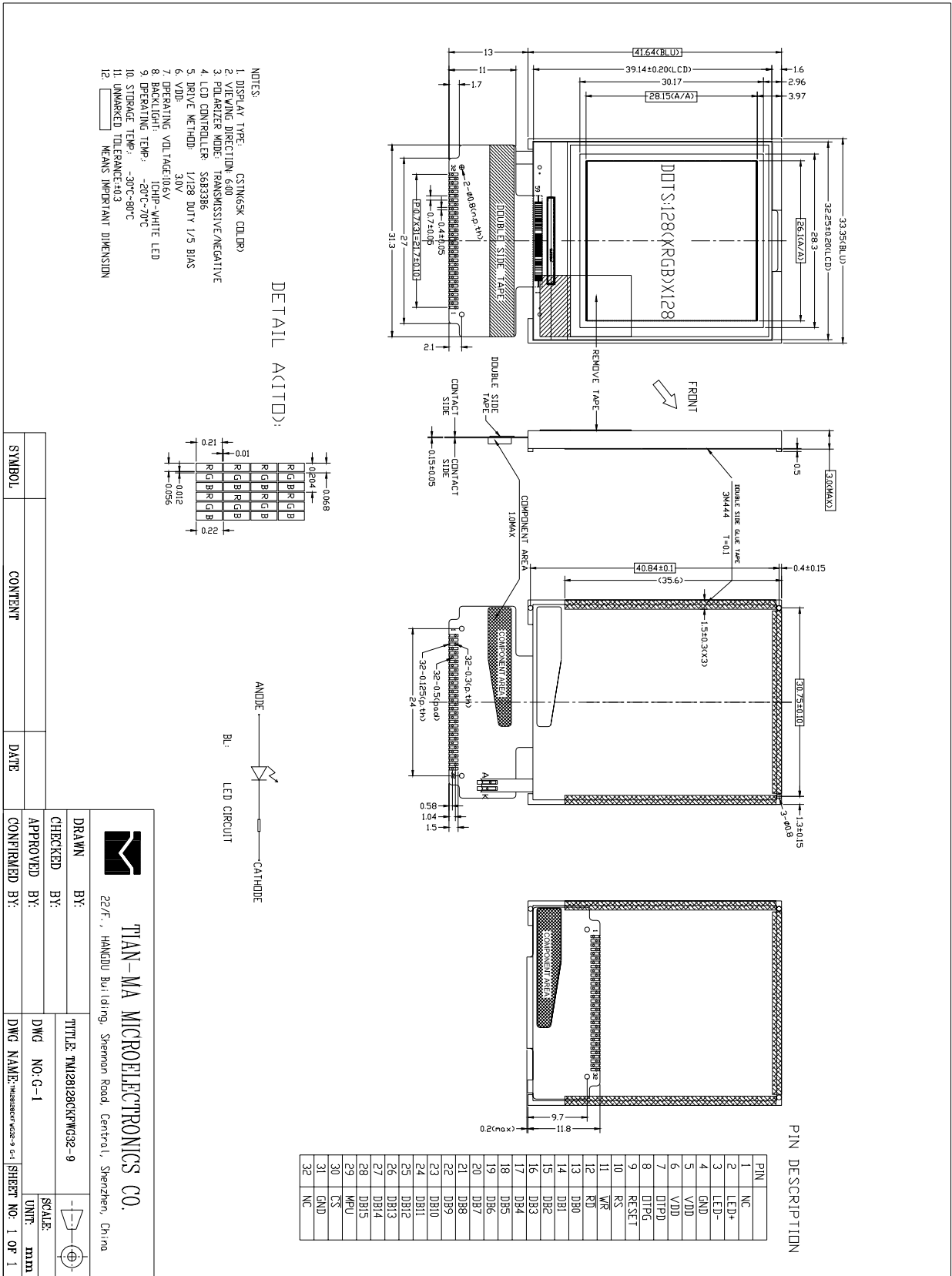

### 3. Circuit Block Diagram

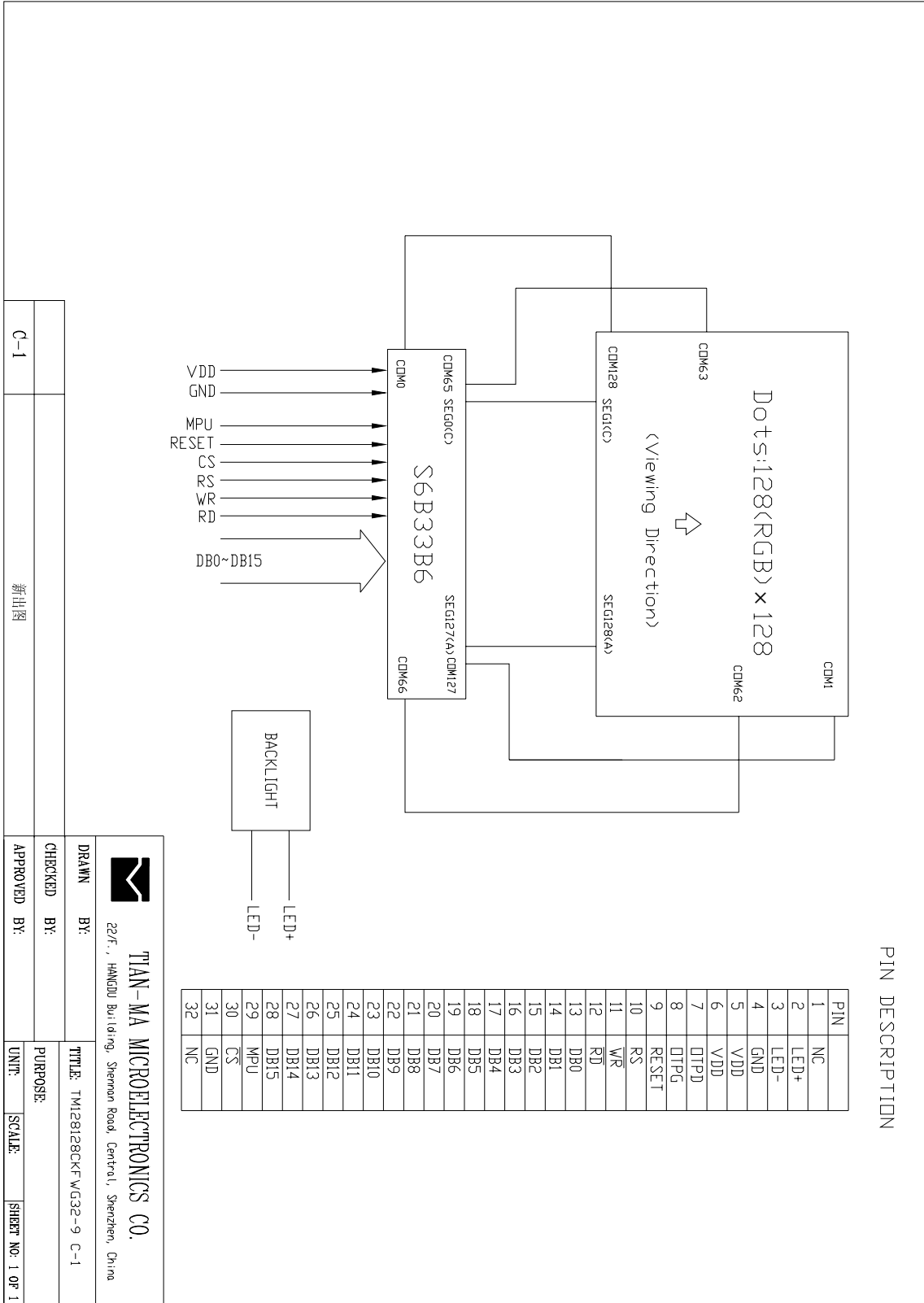

#### 4. Absolute Maximum Ratings(Ta=25 °C)

Item	Symbol	Min.	Max.	Unit	Note
Power Supply Voltage	V <sub>DD</sub>	-0.3	3.3	V	
Power Supply Voltage for LCD	V <sub>op</sub>	-	12	V	
Logic Signal Input Voltage	V <sub>I</sub>	-0.3	V <sub>DD</sub> +0.3	V	
Operating Temperature	Top	-20	+70	°C	
Storage Temperature	Tst	-30	+80	°C	

Notes:

1. If the module is above these absolute maximum ratings. It may become permanently damaged. Using the module within the following electrical characteristic conditions are also exceeded, the module will malfunction and cause poor reliability.
2. V<sub>DD</sub> > V<sub>SS</sub> must be maintained.

## 5. Electrical Specifications and Instruction Code

### 5.1 Electrical characteristics (Ta=25°C)

Parameter	Symbol	Condition	Min	Typ	Max	Unit	Note
Operation voltage	$V_{OP}$	Ta=25°C	10.3	10.6	10.9	V	1
Input voltage	‘H’	$V_{IH}$	$V_{DD}=3.0V$	$0.8V_{DD}$	-	$V_{DD}$	V
	‘L’	$V_{IL}$	$V_{DD}=3.0V$	$V_{SS}$	-	$0.2V_{DD}$	V
Output Voltage	‘H’	$V_{OH}$	-	$0.8V_{DD}$	-	$V_{DD}$	V
	‘L’	$V_{OL}$	-	$V_{SS}$	-	$0.2V_{DD}$	V
Current Consumption	$I_{CC1}$	Normal mode	-	22	30	mA	2
	$I_{CC2}$	Stand-by mode	-	-	-	mA	3

Note:

- 1: IC default setting, Duty:1/128,Bias:1/5.
- 2: Display full white. Backlight on state.
- 3: IC on standby mode.



## 5.2 LED backlight specification

Item	Symbol	Condition	Min	Typ	Max	Unit	Note
Forward voltage	$V_f$	$I_f=20mA$		3.6		V	
Reverse voltage	$V_r$				4	V	
Forward current	Normal	$I_{pn}$	1-chip	20		mA	
	Dimming	$I_{pd}$					
Reverse Current	$I_r$	$V_r=4V$			15	$\mu A$	
Uniformity		$I_f=20mA$	80%				

### 5.3 Interface Signals

Pin No.	Symbol	Function
1	NC	Dummy
2	LED+	Back light+
3	LED-	Back light -
4	GND	Ground
5	VDD	Power supply
6	VDD	Power supply
7	OTPD	OTP pin
8	OTPG	OTP pin
9	RESET	Reset input pin.
10	RS	Data/instruction select input pin
11	WR	Write execution control pin
12	RD	Read execution control pin
13	D0	Data bus
14	D1	
15	D2	
16	D3	
17	D4	
18	D5	
19	D6	
20	D7	
21	D8	
22	D9	
23	D10	
24	D11	
25	D12	
26	D13	
27	D14	
28	D15	
29	MPU	MPU interface select pin(L 8080, H 6800)
30	CS	Chip select pin
31	GND	Ground
32	NC	Dummy

## 5.4 Interface Timing Chart

Note: Please refer to SAMSUNG's S6B33B6 data sheet for more details.

### SAMSUNG S6B33B6 INTERFACE PROTOCOL

#### Read/Write Characteristics (8080-series MPU)

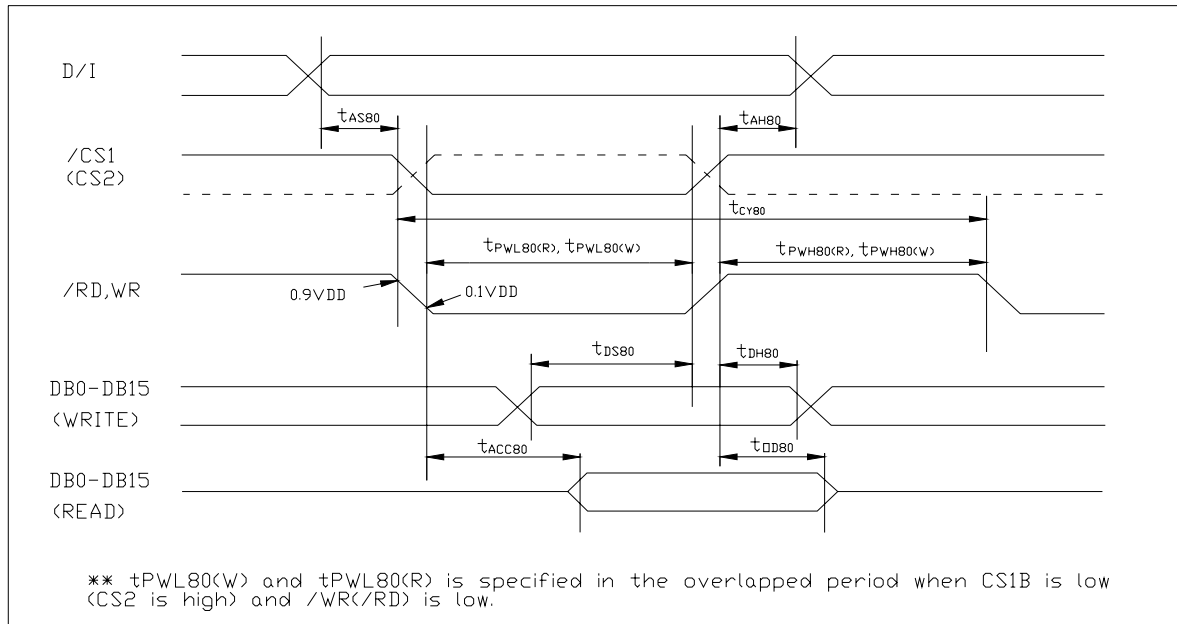

Figure. Parallel Interface (8080-series MPU) Timing Diagram

Table. AC Characteristics(8080-series parallel Mode) ( $V_{DD3}=1.8\sim 3.3V, T_a=-30\sim +70^{\circ}C$ )

Item	Signal	Symbol	Condition	Min.		Max.	Unit
				3.3V	1.8V	(3.3V/1.8V)	
Address setup time	D/I	$t_{AS80}$		0	0	-	ns
Address hold time		$t_{AH80}$		0	0	-	ns
System cycle time		$t_{CY80}$		150	360	-	ns
Pulse width low for write	WRB	$t_{PWLW}$		50	100	-	ns
Pulse width high for write	(WRB)	$t_{PWHW}$		100	75	-	ns
Pulse width low for read	RDB	$t_{PWLR}$		50	100	-	ns
Pulse width high for read	(RDB)	$t_{PWHR}$		30	75	-	ns
Data setup time	DB0	$t_{DS80}$		5	10	-	ns
Data hold time	to	$t_{DH80}$		8	14	-	ns
Read access time	DB15	$t_{ACC80}$	CL=100pF	-	-	60/120	ns
Output disable time		$t_{OD80}$				$t_{EWHR}$	ns

NOTE\*1.The input signal rise time and fall time( $t_r, t_f$ ) is specified at 10 ns or less.

( $t_r+t_f$ )<( $t_{CY80}-t_{PWLW}-t_{PWHW}$ ) for write, ( $t_r+t_f$ )<( $t_{CY80}-t_{PWLR}-t_{PWHR}$ ) for read.

## INSTRUCTION DESCRIPTION

Instruction Name	DI	WRB	RDB	Instruction Table										Hex	Parameter
				DB15 ~ DB8	DB7	DB6	DB5	DB4	DB3	DB2	DB1	DB0			
Non Operation	0	0	1	*	0	0	0	0	0	0	0	0	00		
Oscillation Mode Set	0	0	1	*	0	0	0	0	0	0	1	0	02	1Byte	
Driver Output Mode Set	0	0	1	*	0	0	0	1	0	0	0	0	10	1Byte	
DC-DC Select	0	0	1	*	0	0	1	0	0	0	0	0	20	1Byte	
Bias Set	0	0	1	*	0	0	1	0	0	0	1	0	22	1Byte	
DCDC Clock Division Set	0	0	1	*	0	0	1	0	0	1	0	0	24	1Byte	
DCDC and AMP ON/OFF Set	0	0	1	*	0	0	1	0	0	1	1	0	26	1Byte	
Temperature Compensation Set	0	0	1	*	0	0	1	0	1	0	0	0	28	1Byte	
Contrast Control(1)	0	0	1	*	0	0	1	0	1	0	1	0	2A	1Byte	
Contrast Control(2)	0	0	1	*	0	0	1	0	1	0	1	1	2B	1Byte	
Standby Mode OFF	0	0	1	*	0	0	1	0	1	1	0	0	2C	-	
Standby Mode ON	0	0	1	*	0	0	1	0	1	1	0	1	2D	-	
DDRAM Burst Mode OFF	0	0	1	*	0	0	1	0	1	1	1	0	2E	-	
DDRAM Burst Mode ON	0	0	1	*	0	0	1	0	1	1	1	1	2F	-	
Addressing Mode Set	0	0	1	*	0	0	1	1	0	0	0	0	30	1Byte	
ROW Vector Mode Set	0	0	1	*	0	0	1	1	0	0	1	0	32	1Byte	
N-line Inversion Set	0	0	1	*	0	0	1	1	0	1	0	0	34	1Byte	
Entry Mode Set	0	0	1	*	0	1	0	0	0	0	0	0	40	1Byte	
X-address Area Set	0	0	1	*	0	1	0	0	0	0	1	0	42	1Byte	
Y-address Area Set	0	0	1	*	0	1	0	0	0	0	1	1	43	1Byte	
RAM Skip Area Set	0	0	1	*	0	1	0	0	0	1	0	1	45	-	
Display OFF	0	0	1	*	0	1	0	1	0	0	0	0	50	-	
Display ON	0	0	1	*	0	1	0	1	0	0	0	1	51	-	
Specified Display Pattern Set	0	0	1	*	0	1	0	1	0	0	1	1	53	1Byte	
Partial Display Mode Set	0	0	1	*	0	1	0	1	0	1	0	1	55	1Byte	
Partial Display Start Line Set	0	0	1	*	0	1	0	1	0	1	1	0	56	1Byte	
Partial Display End Line Set	0	0	1	*	0	1	0	1	0	1	1	1	57	1Byte	
Area Scroll Mode Set	0	0	1	*	0	1	0	1	1	0	0	1	59	1Byte	
Scroll Start Line Set	0	0	1	*	0	1	0	1	1	0	1	0	5A	1Byte	
Scroll Start Line Set	X	X	X	*	1	1	1	1	1	1	0	0	FC	1Byte	
Display Data Write	1	0	1											-	-
Display Data Read	1	1	0											-	-
Status Read	0	1	0	0										-	-
Test Mode1	0	0	1	*	1	1	1	1	1	1	1	1	FF	-	
Test Mode2	0	0	1	*	1	1	1	1	1	1	1	0	FE	-	
Test Mode3	0	0	1	*	1	1	1	1	1	1	0	1	FD	-	
Test Mode4	0	0	1	*	1	1	1	1	1	0	1	1	FB	-	
Test Mode5	0	0	1	*	1	1	1	1	1	0	1	0	FA	-	
Test Mode6	0	0	1	*	1	1	1	1	1	0	0	1	F9	-	

\*: Don't care

## 6. Optical Characteristics

Item	Symbol	Condition	Min.	Typ.	Max.	Unit	Note
Brightness	Bp	$\Phi_1=0^\circ$	80			Cd/m <sup>2</sup>	1
Uniformity	$\Delta Bp$	$\Phi_2=0^\circ$	70%				1,2
Viewing Angle	$\Phi_1$ (up down)	$Cr \geq 2$	-40~+35			Deg	3
	$\Phi_2$ (left right)		-30~+30				
Contrast Ratio	Cr	$\Phi_1=0^\circ$ $\Phi_2=0^\circ$	30	40	60	-	4
Response Time	Tr		-	-	180	ms	5
	Tf		70	-	90		
Color of CIE Coordinate	W	x	-	0.30	-	-	1,6
		y	-	0.36	-	-	
	R	x	-	0.53	-	-	
		y	-	0.37	-	-	
	G	x	-	0.31	-	-	
		y	-	0.51	-	-	
	B	x	-	0.16	-	-	
		y	-	0.18	-	-	
NTSC Ratio	S		25%				

Note 1: The data are measured after LEDs are turned on for 5 minutes. LCM displays full white. The brightness is the average value of 9 measured spots. Measurement equipment PR-705 ( $\Phi 10\text{mm}$ )

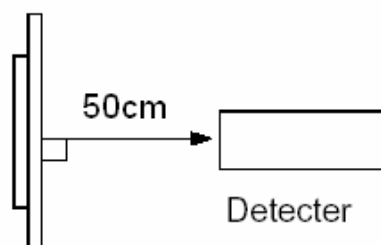

Note 2:  $\Delta B_p = B_p (\text{Min.}) / B_p (\text{Max.}) \times 100 (\%)$

$B_p (\text{Max.})$  = Maximum brightness in 9 measured spots

$B_p (\text{Min.})$  = Minimum brightness in 9 measured spots.

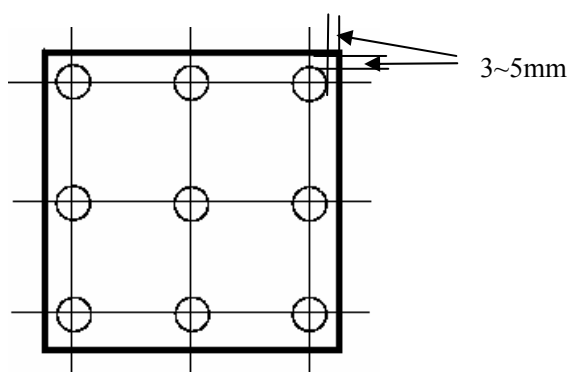

Measurement equipment PR-705 ( $\Phi 10\text{mm}$ )

Note 3: Definition of Viewing Angle (Test LCD using DMS501)

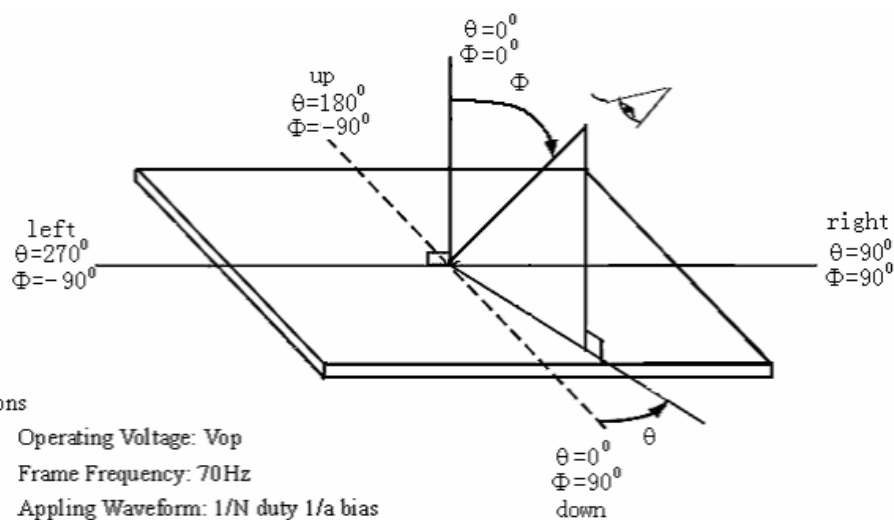

Note 4: Definition of contrast ratio.( Test LCD using DMS501)

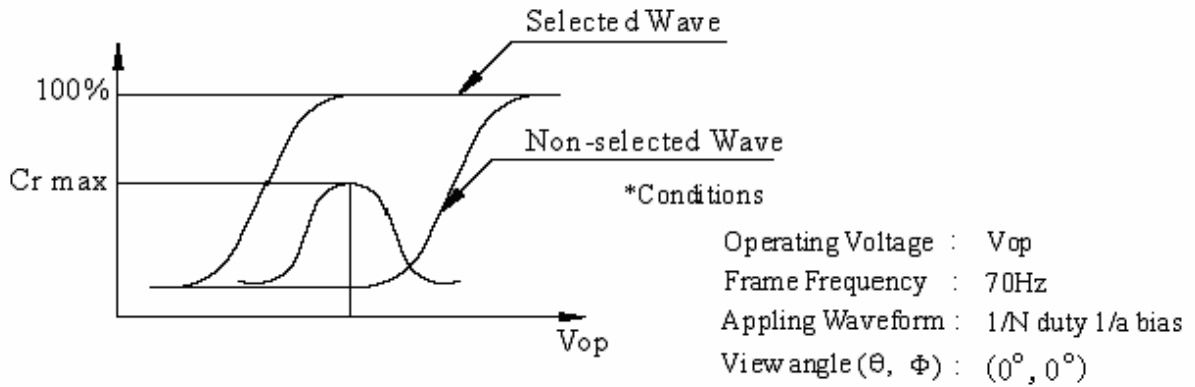

$$\text{Contrast ratio}(Cr) = \frac{\text{Brightness of selected dots}}{\text{Brightness of non-selected dots}}$$

Note 5: Definition of Response time( Test LCD using DMS501)

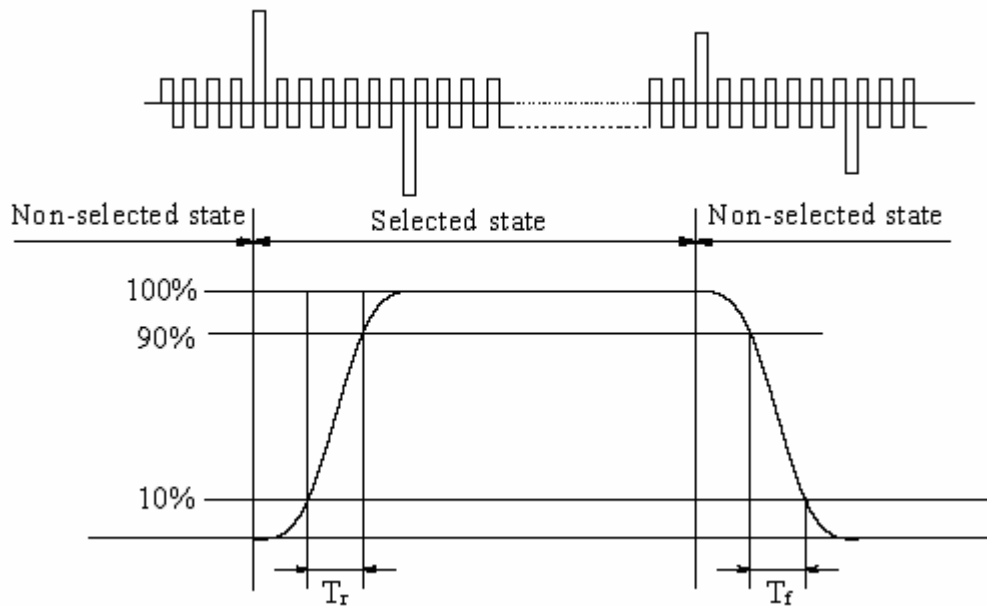

Operating Voltage: Vop  
 Frame Frequency: 70Hz  
 Applying Waveform: 1/N duty 1/a bias  
 View angle (θ, Φ): (0°, 0°)

Note 6: Definition of Color of CIE Coordinate and NTSC Ratio.

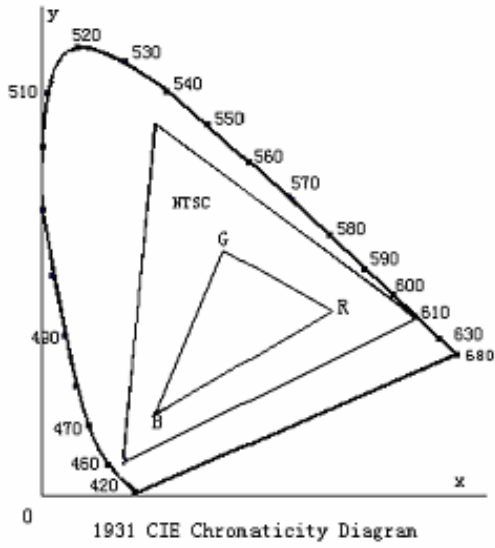

Color gamut:

$$S = \frac{\text{area of RGB triangle}}{\text{area of NTSC triangle}} \times 100\%$$



## 7. Reliability

No.	Test Item	Test condition	Criterion
1	High Temperature Storage	80℃±2℃ 96H Restore 4H at 25℃	1. After testing, cosmetic defects should not happen. 2.Total current consumption should not be over 10% of initial value.
2	Low Temperature Storage	-30℃±2℃ 96H Restore 4H at 25℃	
3	High Temperature Operation	70℃±2℃ 48H Restore 4H at 25℃	
4	Low Temperature Operation	-20℃±2℃ 48H Restore 4H at 25℃	
5	High Temperature /Humidity Storage	40℃±2℃ 90%RH 48H	
6	Temperature Cycle	-30℃←→25℃←→80℃ 5min   30min  ←→25℃ , 5min after 10cycle, Restore 4H at 25℃	
7	Vibration Test (package state)	10Hz~150Hz, 100m/s <sup>2</sup> , 120min	Not allowed cosmetic and electrical defects.
8	Shock Test (package state)	Half- sine wave, 300m/s <sup>2</sup> , 18ms	
9	Atmospheric Pressure Test	25kPa 16H Restore 2H	
10	Cable Bending Test	Bending area and angle follow design document requirement	More than 50000 times

## 8 Quality level

### 8.1 Notes for quality standard

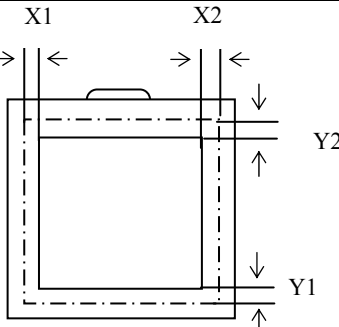
	Note		
General	1. Should any defects which are not specified in this standard happen, additional standard shall be determined by mutual agreement between customer and Tianma. 2. Viewing Area should be the area which Tianma guarantees. 3. Limited sample should be prior to this Inspection standard. 4. Viewing Judgement should be under static pattern. 5. Inspection conditions Inspection distance : 250 mm (from the sample) Temperature : 25±5 °C Inspection angle : 45degrees in LCD view direction		
Definitions of Inspection items	Pinhole, Bright spot, Black spot, White spot, Black line, White Line, Foreign particle, Bubble	The color of a small area is different from the remainder. The phenomenon dose not change with voltage.	
	Contrast variation	The color of a small area is different from the remainder. The phenomenon changes with voltage.	
	Polarizer defect	Scratch, Dirt, Particle, Bubble on polarizer or between polarizer and glass.	
	Glass defect	Glass crack, Shaved corner of glass, Surplus glass	
Definitions of Inspection ranges	 <p style="text-align: center;">Dividing A zone and B zone proceed to make a judgment.</p> <p>A zone : Inside Viewing area                      B zone : Outside Viewing area                      X1(A.A~V.A): mm                      X2(A.A~V.A): mm                      Y1(A.A~V.A): mm                      Y2(A.A~V.A): mm</p>		
Outgoing Inspection standard	Inspection level II Normal Inspection Sampling standard conforms to GB2828		
	Rank	Inspection Item	AQL(Number of defective LCMs counted)
	Major defect	All Functional defects(Such as No display, Display abnormally, Open or missing segment, Short circuit, Missing component, No sound, Blight abnormally),Outline dimension beyond the drawing	0.65
Minor defect	Appearance defects, such as Black/White spot, Bright spot, Pinhole, Black/White line, Contrast variation, Bubble Glass defect, Polarizer defect, and so on. Details of the standard as follows.	1.50	

## 8.2 Standards of inspection items

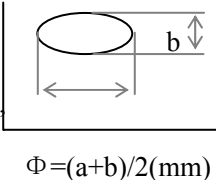
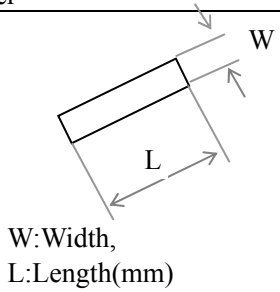
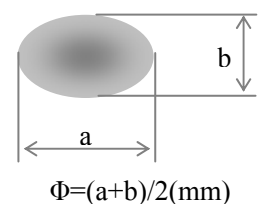
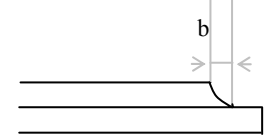
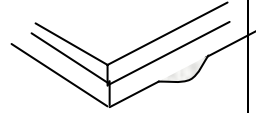
Inspection item		Judgement standard				
		Category		Acceptable number		
				A zone	B zone	
1	Black spot, White spot Bright Spot, Pinhole Foreign Particle, Bubble and Particle Between polarizer and glass, Scratch on polarizer		A	$\Phi \leq 0.15$	Neglecte	Neglected
			B	$0.15 < \Phi \leq 0.20$		
			C	$0.20 < \Phi \leq 0.30$	1	
			D	$0.30 < \Phi$	0	
			Total defective point(B,C)		3	
2	Black line, White line, Bubble and Particle Between Polarizer and glass, Scratch on polarizer		A	$W \leq 0.10$	Neglected	Neglected
			B	$0.01 < W \leq 0.03$ $L \leq 3.0$		
			C	$0.03 < W \leq 0.05$ $L \leq 3.0$	1	
			D	$0.05 < W$	0	
			Total defective point(B,C)		2	
3	Contrast variation		A	$\Phi \leq 0.2$	Neglected	Neglected
			B	$0.2 < \Phi \leq 0.3$		
			C	$0.3 < \Phi \leq 0.4$	1	
			D	$0.4 < \Phi$	0	
			Total defective point(B,C)		3	
4	Bubble inside cell		any size		none	none
5	Polarizer defect (if Polarizer is used)	Scratch and damage on polarizer, Particle on polarizer or between polarizer and glass.  Bubble, dent and convex	Refer to item 1 and item 2.			
			A	$\Phi \leq 0.3$	Neglected	Neglected
			B	$0.3 < \Phi \leq 0.7$		
			C	$0.7 < \Phi$	0	
Total defective point(B,C)		2				
6	Surplus glass	①Stage surplus glass 	$b \leq 0.3\text{mm}$			
		②Surrounding surplus glass 	Should not influence outline dimension and assembling.			

Inspection item		Judgment standard									
		Category(application: B zone)									
7	Glass defect crack	①The front of lead terminals	<table border="1"> <tr> <td>A</td> <td>If <math>a \leq t</math> and <math>b \leq 1.0</math>, <math>c</math> is not limited</td> </tr> <tr> <td>B</td> <td><math>a \leq t</math>, <math>1 \leq b \leq 2\text{mm}</math>, <math>c \leq 3\text{mm}</math></td> </tr> <tr> <td>C</td> <td>If glass crack cover alignment mark, <math>b \leq 0.5\text{mm}</math>.</td> </tr> <tr> <td>D</td> <td>Crack at two sides of lead terminals should not cover patterns and alignment mark</td> </tr> </table>	A	If $a \leq t$ and $b \leq 1.0$ , $c$ is not limited	B	$a \leq t$ , $1 \leq b \leq 2\text{mm}$ , $c \leq 3\text{mm}$	C	If glass crack cover alignment mark, $b \leq 0.5\text{mm}$ .	D	Crack at two sides of lead terminals should not cover patterns and alignment mark
		A	If $a \leq t$ and $b \leq 1.0$ , $c$ is not limited								
		B	$a \leq t$ , $1 \leq b \leq 2\text{mm}$ , $c \leq 3\text{mm}$								
		C	If glass crack cover alignment mark, $b \leq 0.5\text{mm}$ .								
D	Crack at two sides of lead terminals should not cover patterns and alignment mark										
②Surrounding crack—non-contact side seal	$b < \text{Inner borderline of the seal}$										
③ Surrounding crack— contact side	$b < \text{Outer borderline of the seal}$										
④Corner	<table border="1"> <tr> <td>A</td> <td><math>a \leq t</math>, <math>b \leq 3.0</math>, <math>c \leq 3.0</math></td> </tr> </table> <p>*Glass crack should not cover patterns used for</p>	A	$a \leq t$ , $b \leq 3.0$ , $c \leq 3.0$								
A	$a \leq t$ , $b \leq 3.0$ , $c \leq 3.0$										

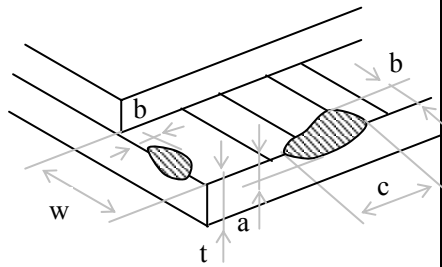

②Surrounding crack—non-contact side seal

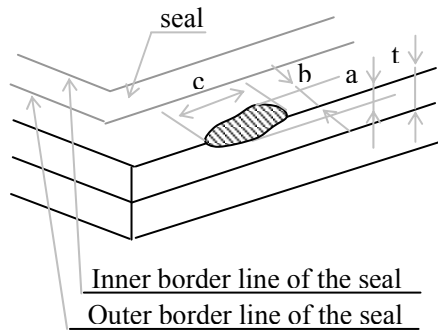

③ Surrounding crack— contact side

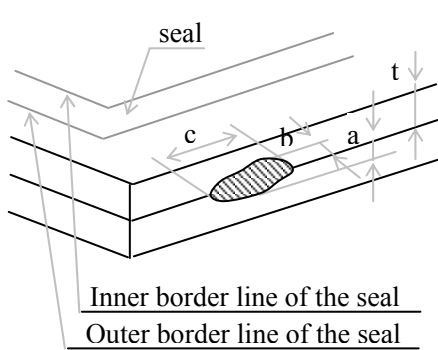

④Corner

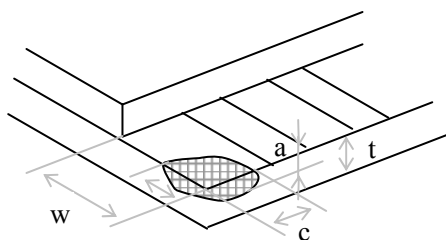

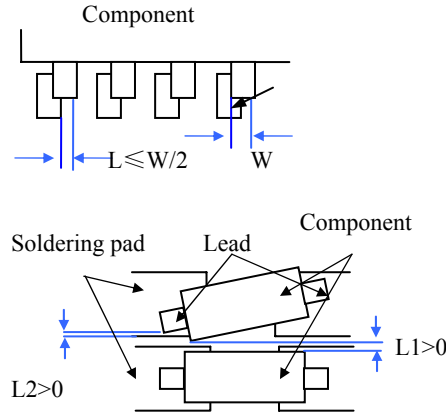
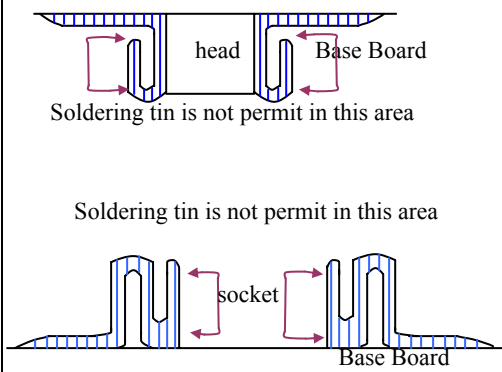
Inspection item		Judgement standard	
8	PCB defect	<p>Component soldering:                      No cold soldering、 short、 open circuit、 burr、 tin ball                      The flat encapsulation component position deviation must be less than 1/2 width of the pin (Pic.1);                      the sheet component deviation:                      Pin deviates from the pad and contact with the near components is not permitted (Pic.2)</p>	
		<p>lead defect:                      The lead lack must be less than 1/2 of its width;                      The lead burr must be less than 1/2 of the seam;                      Impurities connect with the near leads is not permitted</p>	
		<p>Connector soldering:                      Soldering tin is at contact position of the plug and socket is not permitted                      No foundation is scald                      Serious cave distortion on plug and socket contact pin is not permitted</p>	

## 9. Precautions for Use of LCD Modules

### 9.1 Handling Precautions

9.1.1 The display panel is made of glass. Do not subject it to a mechanical shock by dropping it from a high place, etc.

9.1.2 If the display panel is damaged and the liquid crystal substance inside it leaks out, be sure not to get any in your mouth, if the substance comes into contact with your skin or clothes, promptly wash it off using soap and water.

9.1.3 Do not apply excessive force to the display surface or the adjoining areas since this may cause the color tone to vary.

9.1.4 The polarizer covering the display surface of the LCD module is soft and easily scratched. Handle this polarizer carefully.

9.1.5 If the display surface is contaminated, breathe on the surface and gently wipe it with a soft dry cloth. If still not completely clear, moisten cloth with one of the following solvents:

— Isopropyl alcohol

— Ethyl alcohol

Solvents other than those mentioned above may damage the polarizer. Especially, do not use the following:

— Water

— Ketone

— Aromatic solvents

9.1.6 Do not attempt to disassemble the LCD Module.

9.1.7 If the logic circuit power is off, do not apply the input signals.

9.1.8 To prevent destruction of the elements by static electricity, be careful to maintain an optimum work environment.

a. Be sure to ground the body when handling the LCD Modules.

b. Tools required for assembly, such as soldering irons, must be properly ground.

c. To reduce the amount of static electricity generated, do not conduct assembly and other work under dry conditions.

- d. The LCD Module is coated with a film to protect the display surface. Be care when peeling off this protective film since static electricity may be generated.

## **9.2 Storage precautions**

9.2.1 When storing the LCD modules, avoid exposure to direct sunlight or to the light of fluorescent lamps.

9.2.2 The LCD modules should be stored under the storage temperature range. If the LCD modules will be stored for a long time, the recommend condition is:

Temperature :           0℃ ~ 40℃

Relatively humidity: ≤80%

9.2.3 The LCD modules should be stored in the room without acid, alkali and harmful gas.

**9.3** The LCD modules should be no falling and violent shocking during transportation, and also should avoid excessive press, water, damp and sunshine.